

INSTALLATION AND USER'S MANUAL

MONROE 900

G20/G25 (Natural Gas) G30/G31 (Propane-Butane/Propane)

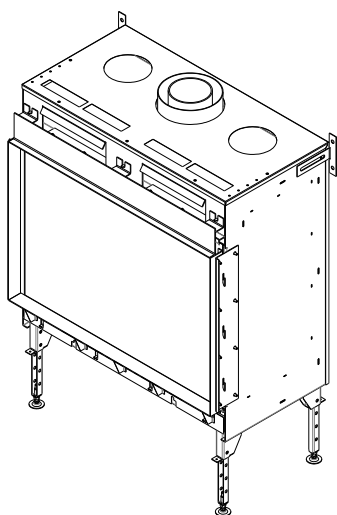

Single Sided

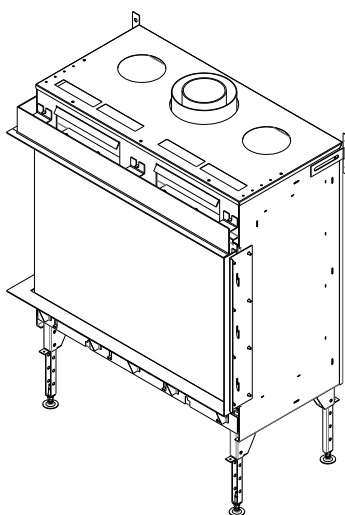

Left / Right Corner

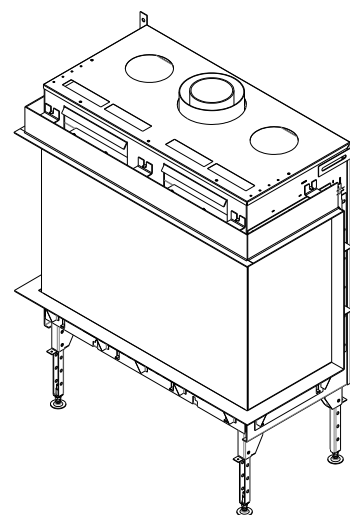

Three Sided

Produced by:
Planika Sp. z o.o.
Bydgoskich Przemysłowców 10
85-862 Bydgoszcz, Poland
Telephone: + 48 52 364 11 60

IT IS OBLIGATORY TO READ AND STORE THIS INSTALLATION MANUAL.

TABLE OF CONTENTS

1.	INTRODUCTION	4
2.	GENERAL INFORMATION	5
3.	SAFETY	5
3.1.	Safety instructions for MONROE's fireplace installation	6
3.2.	Safety instructions for the use of fireplace powered by gas cylinder	7
4.	UNPACKING	8
4.1	Table of the Elements:	8
5.	INSTALLATION.....	8
5.1.	Type of gas	8
5.2.	Conversion to another type of gas	8
5.3.	Gas connection	9
5.4.	Electrical connection	9
5.4.1.	Connecting additional lighting or other electric receivers.....	10
5.5.	Device positioning	10
5.6.	Fireplace housing execution	12
5.6.1.	Installation of the Monroee Single Sided	13
5.6.2.	Installation of the Monroe Left / Right Corner	13
5.6.3.	Installation of the Monroe Three- Sided	14
5.7.	Fireplace housing with platform.....	14
5.7.1.	Fireplace housing in combination with bottom decorative frame	14
5.7.2.	Fireplace housing without decorative frame.....	16
5.7.3.	Adjustment of the upper decorative frame.....	18
5.8.	Placing the inspection hatch.....	18
5.9.	The exhaust and combustion air supply system	20
5.9.1.	General Information	20
5.9.2.	Recommendations for proper installation of the concentric flue system	21
5.9.3.	Construction of the concentric flue system.....	21
5.9.4.	Distances of the exhaust outlet from the structural elements of the building.....	28
5.10.	Ventilation and air circulation inside the fireplace housing	30
5.11.	Placing decorative elements.....	31
5.11.1.	Arranging decorative logs.....	32
5.12.	Glasses.....	37
5.12.1.	Assembly of the glass panel	37
5.12.2.	Dissassembly of the glass.....	39
6.	CONTROL	41
6.1.	Remote controls	42
6.1.1.	Remote control for the user	42
6.1.2.	Orange remote control for the installer	42
6.2.	Alternative ways of control	42
6.2.1.	Wired connection.....	42
7.	FINAL INSPECTION	44
7.1.	Gas tightness	44
7.2.	Gas Pressure.....	44

7.3.	Ignition of the main burner	44
7.3.1.	First ignition of the device after installation or after modifications	44
7.3.2.	The Hearth.....	45
7.4.	Flame.....	46
7.5.	Checklist	46
8.	USAGE.....	47
8.1.	First use	47
8.2.	Discoloration of walls and ceilings.....	47
9.	REMOTE CONTROL	47
9.1.	Display and buttons.....	47
9.2.	Explanation of symbols.....	48
9.3.	Setting connection between the remote control and the receiver	48
9.3.1.	Battery exchange.....	49
10.	USER MENU	50
10.1.	Eco Flow	50
10.2.	Relay - control of additional optional lighting	50
10.3.	Fan or damper control.....	51
10.4.	The choice of control options	51
10.5.	Date and time settings	52
10.6.	Setting the time schedule.....	52
11.	INSTALLATION MENU	53
11.1.	Time format of 12-hour or 24-hour.....	53
11.2.	Time schedule (1day, 5 + 2, 7 days or manual).....	53
11.3.	The periods during the day (II, IV or VI).....	54
11.4.	User Menu Settings	54
12.	CONTROL	55
12.1.	Manual control	55
12.1.1.	Ignition of the device.....	55
12.1.2.	Flame height adjustment	56
12.1.3.	Temperature regulation	56
12.1.4.	Temporary disruption of the temperature control.....	57
12.1.5.	Switching on and off the log burners	57
12.1.6.	Turning off the device	58
12.2.	Automatic control - Time Schedule	58
12.2.1.	Temporary change of temperature setpoint.....	58
12.2.2.	Temporary disruption of the time schedule	58
13.	SIGNAL QUALITY	59
14.	TROUBLESHOOTING	59
15.	MAINTENANCE	61
15.1.	Spare parts	61
15.2.	Cleaning of the glass with anti-reflective coating (if delivered).....	61
16.	ENVIRONMENTAL PROTECTION	61
16.1.	The device	62
17.	DELIVERY	62
18.	TECHNICAL SPECIFICATIONS.....	63
19.	WARRANTY	63

1. INTRODUCTION

The Planika company designs and manufactures gas heating devices that meet the highest standards of quality, efficiency and safety. The device has a CE marking, which means that it meets the essential requirements of the Directive of the European Parliament and European Council 2009/142 / EC of 30 November 2009 and Regulation (EU) 2016/426 relating to Devices burning gas and compliant is with Standard EN 613 on convection space gas heaters, and EN 778: 2010.

Each gas fireplace produced by Planika is subjected to factory quality control, during which it undergoes rigorous safety tests. Materials of the highest quality used for its production guarantee the user a smooth and reliable functioning of the device.

The device is delivered together with the instruction manual and assembly instructions. The assembly instructions provide the necessary information to install the device in such a way that it works properly and safely. In addition, you can find technical data about the device, information on its maintenance and possible failures that may occur, along with their possible causes and how to resolve them.

WARNING! The installer must be a certified and qualified specialist in gas heating and electricity and should have all the qualifications required by local law.

CE Declaration of conformity

We hereby declare that both the design and construction of a gas heating device manufactured by Planika Sp. z o.o. (with registered office at Bydgoskich Przemysłowców 10 85-862 Bydgoszcz, Poland) meet the essential requirements contained in the Directive and the Ordinance on gas appliances.

Product: Convection space gas heater with closed combustion chamber, equipped with concentric air combustion pipe system with natural gravity, type C11 (without a fan) and the type of C31 (without a fan) and C91 (without a fan).

Type: MONROE 900, MONROE 1150, VALENTINO 1000, VALENTINO 1300 in versions: LF, F, FR, LFR

Directives: 2009/142 / EC; 2014/35 / EU; 2014/30 / EU

Regulation: 2016/426 / EU

Standards: EN-613; EN-613/A1; PN-EN 778:2010; PN-EN 437+A1:2012; PN-EN 60335-2-102

The notified body: the Oil and Gas Institute - National Research Institute (Lubicz 25 A street, 31-503 Kraków, Unit number: 1450) carried out and on 27/04/2017 issued the certificate no. GAR1450CS0005 for the above mentioned devices.

The company's quality control system guarantees that the mass-produced devices meet the essential requirements of the applicable Directives and Regulations as well as the standards contained therein. This Declaration is annulled if any modifications are made to the device without the prior written consent of Planika.

Brzoza 02.02.2018

PREZES ZARZĄDU
Jarosław Dąbrowski

Chairman of the Board
Jarosław Dąbrowski

The object of the declaration described above is in line with the relevant EU legislation: Directive 2009/142 / EC (until 20 April 2018) and Regulation (EU) 2016/426 (from April 21, 2018)

2. GENERAL INFORMATION

MONROE gas fireplaces are gas powered heating devices with closed combustion chamber, which use first-class advanced automation to control the gas valve. The device complies with European directives with regards to safety, the environment and energy consumption. Thanks to the use of the concentric flue system, the air supplied to the combustion chamber via the outer pipe is drawn from outside the building. The entire system is completely closed, which prevents the exhaust gases entering directly into the room where the fireplace is located. This provides the user with 100% security thanks to separation of the products of combustion, which are removed efficiently out of the building through the inner pipe of concentric system.

MONROE Gas fireplaces series are intended for indoor use only, and can be powered by natural gas or liquefied natural gas propane or propane-butane. The device is manufactured in four variants of glazing, in accordance with the accessibility for each installed, so as to be able to fully meet the needs of even the most demanding customers. Regardless of the glazing and the length of the chimney, MONROE fireplaces are equipped with automatic control and protection of the same type, and their connection to the gas system and the flue system is identical. The user also has the option of choosing the version of the interior of the fireplace and control it by using remote control supplied together with the device, through automation system of intelligent buildings or use for this purpose a built-in thermostat unit.

3. SAFETY

WARNING! It is mandatory to make sure to carefully read the installation manual and user manual before beginning of installation and operation of the fireplace series MONROE. This manual should be retained for the life time of the device.

WARNING! The device must be installed in accordance with the relevant national and local regulations. Connection to the flues, wall and roof passage as well as all elements used to install the fireplace should be made in accordance with existing norms of the national building legislation.

To ensure the secure installation and perfect operation of the device, observe the following precautions and adhere to the following safety rules:

- Read installation manual and user manual before installation and first use of the device.
- The device can be installed and serviced only by certified and skilled professional specializing in the field of gas heating and electricity.
- Installation of the unit must allow easy access to all components subject to maintenance and service, and to allow free access to the components of the system closing the front glass .
- Do not use the device before you fully install it in the chosen destination.
- Fireplace series MONROE should be monitored at least once a year in accordance with this installation manual and as well as all applicable national and local regulations concerning safe installation and use of gas appliances.
- Make sure that the information on the nameplate are consistent with the local type of domestic gas and pressure.
- Do not change the structure of the device and its sealed components or modify the default settings of the fireplace.
- Do not place extra decorative accessories (other than those supplied with the unit) or the glowing coals on the burner or in the combustion chamber.

- The components of the control system with the gas valve cannot be exposed to moisture.
- Carbon dioxide (CO₂) or powder extinguisher must be placed near the unit.
- Before connecting the device you should familiarize yourself with all connecting schemes (including electric), set out in the manual.
- The first time you turn on the fireplace MONROE, it is necessary to use it at the maximum level of the flame for a few hours so that the elements warm themselves, and possible small residues of paints, coatings and lubricants will evaporate.
- During the first hours of use of the device, additional ventilation and ventilation of the room is recommended, to quickly remove the characteristic smell fire resistant paint.

WARNING! When you first start your device, the installer should perform the leak test on all gas connections, check the connections of all elements of the system (including the proper connection to the concentric air combustion system) and check the correct operation of all the items, in particular system of ignition and flame failure protection system.

- Do not move the device during its operation.
- The surface of the fireplace series MONROE may strongly heat up during use - up to more than 100 °C

WARNING! Accessible parts of the devices, including the glass, can become very hot. You absolutely must protect children from contact with the working device!

- Do not operate the machine without inserting the front glass.
- In case of failure of any of the glass panes, please contact your service provider or distributor.
- The device should be installed away from flammable materials.
- All metal parts of the fireplace series MONROE are constructed of materials resistant to rust or covered with corrosion coating.
- Never leave the fireplace MONROE unattended (as in the case of any other type of fireplace or fire in the room). Fireplace series MONROE should be installed out of reach of children, unauthorized persons and animals so direct contact with hot parts of the fireplace is not possible.
- In case of feeling any gas leaks, immediately turn off the fireplace and, depending on the type of fuel, close the main valve on the gas cylinders LPG or close the valve supplying natural gas to the device. You should also ventilate the room in which the fireplace is installed and contact the service staff.
- If the unit is not used for a long time, depending on the type of fuel, close the main valve on the LPG cylinder or close the valve supplying natural gas to the device.

3.1. Safety instructions for MONROE's fireplace installation

- MONROE fireplaces are not standalone devices and are intended only for installation.
- You should install the ventilation grille or make a ventilation gap in the ventilation surface at least 300cm² at the base of the installation to provide adequate circulation in its interior. The device without grating or the ventilation slot on the desired surface will not work properly, creating a danger of overheating and damage to the appliance, or in extreme cases of fire.
- For installation of air combustion wires, you should only use the concentric system supplied by the company Planika.

- For the construction of fireplace housing equipment use only non-flammable materials (e. g. non-combustible and heat-resistant plates or materials made of stone). Non-combustible materials must be used to complete both external as well as internal part of the housing, and for completing the wall, at which the device will be placed.
- Strictly follow the minimum distance between non-combustible walls of the housing and the device.
- To improve the circulation inside the unit and to reduce the risk of overheating of its walls (including the wall, which the device was placed on), you must comply with the distances shown in the mounting drawings.
- Use the electric wires in high-temperature insulation, and place them away from the hot parts of the fireplace and installation items.
- Do not apply any additional insulation (wool, non-woven materials) do not wrap the device in any other material.
- Combustible materials should be placed no closer than within 1 m from the unit.
- Only decorative accessories attached to the device by the manufacturer should be placed on the hearth (logs, stones, vermiculite or ash imitation). These accessories should be installed as described in this manual. Incorrect placement of decorative materials may result in shortening the useful life of the hearth and its damage.

WARNING! Make sure you don't place any decorative elements around the ignition and ionization electrodes.

- Before final installation of the device and start constructing the fireplace housing, make sure the explosion hatches placed at the top of the device are in the correct position and whether they were properly fitted to the sealing surface.

3.2. Safety instructions for the use of fireplace powered by gas cylinder

- Use only the type of gas and pressure specified on the label by the manufacturer.
- Gas cylinders should always be in an upright position - both during use and transport.
- A storage of the gas cylinder should be located in a place easily accessible to allow its immediate closure.
- During installation, never approach the gas flame or any other source of fire.
- Gas cylinder should not be closer than 1.5 m from the fireplace MONROE.
- Any leaks should be located using a mixture of water and foaming cleaning fluid. The resulting air bubbles indicate a leak.
- Always use a pressure reducer between the cylinder and the device. Replace pressure regulator at least every 5 years. Permissible pressure: 30mbar, 37mbar (recommended), 50 mbar. Use only regulators that meet the requirements of European Standard EN16129.
- Use only approved and certified cables connecting gas (flexible hose). Replace them at least every 2 years.
- Flexible hose supplying gas to the unit should be located away from sharp edges and hot surfaces. Avoid bends and twists of flexible connections along the whole length.
- Note that the gas cylinder LPG should be installed in well-ventilated areas. LPG gas is heavier than air and its accumulation on the substrate can lead to the formation of explosive mixtures.

- Optional housing, which cylinder of LPG will be placed at, must have adequate ventilation. It must have an upper ventilation opening above the top of the cylinder (with min 1/100 base surface of the installation) and a lower vent opening at its base (with min 1/50 base surface of the installation).
- Turn off gas cylinder, if the device is not in use.
- Filling the gas cylinders should only be done at certified gas filling stations.
- Exchange of empty bottles for full should take place only at authorized points.

4. UNPACKING

WARNING! Prior to installation refer to the instructions included with the device and check the completeness of the elements on basis of table of the elements.

4.1 Table of the Elements:

- 1 x complete gas fireplace
- 1x installation manual and user's manual
- 1x remote control
- 1x power cord ended up with cube
- 1x gas assembly handle
- 1x set of ceramic logs (or set of decorative stones)

After receiving the unit:

- Carefully remove the packaging of each item.
- Remove all delivered components which have been placed inside or under the device for the time of transport.
- Remove all the screws and brackets, which are used for attaching the device to the pallet.
- Inspect the device and accessories for possible damage caused during transport.
- Contact your dealer if any item from the package is damaged or found to be missing.
- Never start the installation, if the device is damaged.
- The packaging should be disposed in accordance with local regulations.

5. INSTALLATION

WARNING! The installer should be certified and qualified professional in the field of installation of gas and electric.

The device must be installed in accordance with the relevant applicable national and local regulations and to follow the rules or instructions contained in this installation manual.

5.1. Type of gas

Before installing, make sure that the data on the rating plate comply with the local type of domestic gas and pressure, and are in accordance with the type and pressure of gas in the target site. On the rating plate, which is located on the shipping box and next to the gas assembly, you can find type and family of the gas, the gas pressure and the country the device is intended for.

5.2. Conversion to another type of gas

Warning! Conversion of the device to another type of gas can be made only by replacement of the entire main hearth to another suitable for the new type of gas. The conversion can be done only by an authorized gas installer. To do this, contact the distributor. When ordering, always specify type and serial number of the device.

Warning! You should never connect any device adapted to the combustion of liquefied gas to the gas network of natural gas and vice versa.

5.3. Gas connection

Gas control system used in a series of MONROE meets the requirements for appliances burning gaseous fuel contained in directives 2009/142/EC and standards EN 298, EN 55014-1, EN 60730-1, EN 60335.

First and foremost, make sure that the connecting device is designed to supply a gas suitable for the type placed in the gas installation. All necessary information regarding the desired parameters of the gas are found on the rating plate of the device. Before connecting the gas supply, it is necessary to blow them to remove any remaining metal filings and other contaminants from inside. Automatic gas control system should be protected from moisture and dust. These factors may cause irreparable damage to the individual components. The pipe supplying gas to the fireplace should be equipped with a ball valve with a diameter of 1/2 inch. The individual elements of the gas installation cannot be sealed using Teflon tape or PTFE tape.

The gas valve on the gas pipe must be installed in accordance with applicable national regulations. Gas connection "G_{in}" on the main control valve of the fireplace is located next to the controller of the gas valve "C". Before connecting the gas, make sure that the gas pipes and connections have no dirt. Gas connection is finished with internal thread 3/8".

Regarding gas connection, the following requirements shall apply:

- You must use the gas pipe with the correct dimensions, so there are no pressure loss.
- Ball gas valve should be installed in an easily accessible place and have the necessary CE mark.

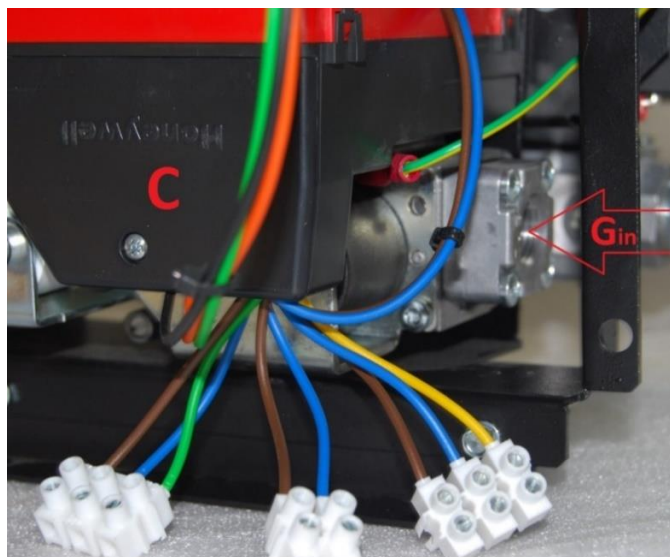

Photo 1 - Gas Connector

5.4. Electrical connection

Fireplaces MONROE requires connection to the mains 230V and should be connected by a person with the appropriate permissions. Remember to use electric cables in the heat-resistant insulation and place them away from the hot parts of the fireplace and installation elements. Electrical components of the gas valve control unit are sensitive to dirt and dust generated during the assembly process of making fireplace housing. Remember to protect against dust and moisture, all electrical components of the fireplace until their final assembly. The electrical connection is completed with triple cube (L, N, PE)

WARNING! Power must be connected only after connecting the air combustion system with all elements of the gas control system.

5.4.1. Connecting additional lighting or other electric receivers

Electronics that control the gas valve gives you the ability to connect an optional lighting (for example, to highlight the interior of the housing) and allows you to control it from the remote control and automation of intelligent building. The exact description of additional lighting control (or other electrical receiver) is described in the user manual.

A built-in relay "L" can be used to control any AC receiver (AC 230V/0,5A). The relay has neutral polarity.

Connector "B" is used for connection of an additional fan or optional throttle (max 230V AC/0,8A) eg. to improve air circulation within the housing or to distribute warm air from inside the housing to the other rooms.

Connector "M" is used for connecting additional gas solenoid, whose task is to turn on and off the side section of the hearth.

Connector "D" gives the possibility to use an alternative method of controlling the fireplace (as described in section 6.2.1). and integrate it through a wired connection with Intelligent Smart Home System (Domotica).

Connector "F" is used to connect the fan (with feedback to the driver), mounted on the air combustion wire, supporting the chimney draft (max 230V AC / 0.8A). This connector cannot be controlled with the remote control and operates independently from the user. **This connector is not active.**

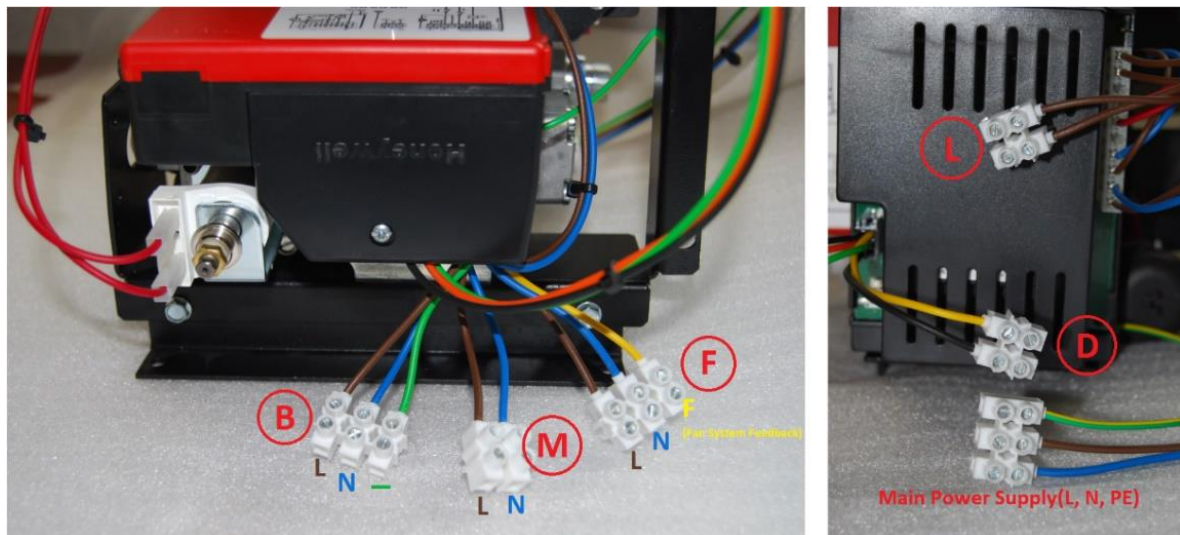

Photo 2 - Diagram of electrical connections

5.5. Device positioning

Before connecting the device to gas and concentric flue system, it should be thoughtful to choose the place of its detention and place it in such way, so that the concentric flue system have the minimum number of bends. This will ensure adequate chimney draft and adequate circulation inside the combustion chamber. It is also important that after you connect the fireplace to a gas pipe, flexible connecting wires are not exposed to excessive twisting and are located away from hot parts.

By acceding to the installation of the unit, particular attention should be paid to:

- The unit was located at a minimum distance of 1m from objects or flammable materials.
- The device was **minimum** 50 mm away from the non-flammable housing elements and the **minimum** distance between the device and the back wall was not less than 50 mm.

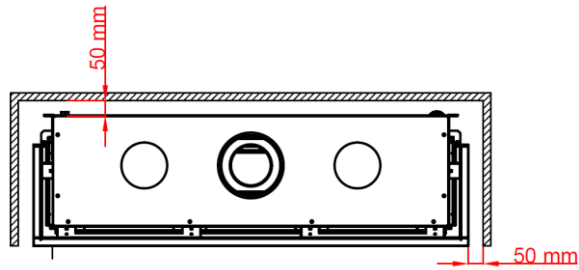

Picture 1 - The minimum required distance from the unit

- Outlet pipes were installed according to the manual.
- The wall, before which the device will be placed at, was made of non-flammable and heat-resistant material.
- Do not use any additional insulation, or wrap the device in any other material.
- The unit was in a stable position and was placed on a flat leveled base. This will be particularly important if the adjustable feet attached to device, will be extended to its maximum height, or when the device is sited in additionally elevated foundation. **WARNING!** Precise leveling the ground and the body of the fireplace will ensure the stability of the device and ensure the tightness of the combustion chamber.
- Minimum structural dimensions of the fireplace housing have been preserved.
- Gas pipeline together with the installed gas valve was supplied at the place of installation.
- Create an opening for the needs of concentric air combustion system with the following diameters:
 - pipe diameter +50 mm for the needs of the channel passing through combustible material;
 - pipe diameter +200 mm for needs of the channel passing through combustible material;

The device should be installed on a stable non-flammable surface. Gas insert is equipped with a special feet (B - Picture 2) with the possibility of adjusting their height and two adjustable mounting brackets (A - Picture 2) to allow attachment of the device to the wall. The mounting brackets (A) are used to maintain the minimum distance from non-combustible walls. It is forbidden to install gas insert without a minimum distance from the rear or side wall. The Assembly is allowed only vertically.

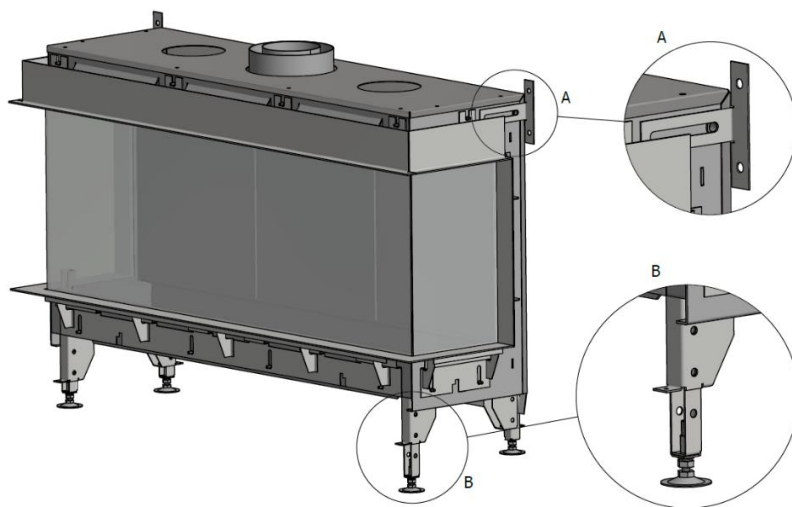

Picture 2 - Location of wall mounting brackets and adjustable feet

5.6. Fireplace housing execution

Before performing the installation, protect the elements of the gas control system from dirt. Installation of the fireplace, according to current building regulations should be made of non-combustible materials (including floor and ceiling). If the fireplace is powered by natural gas (NG), exhaust grille should be placed under the ceiling of the room where the device is installed. Power liquid propane - butane (LPG) requires from the installer placing the exhaust grilles next to the floor, above ground level in the room in which the device is installed.

To perform the installation of the fireplace housing, you should use non-combustible and heat-resistant materials, including its upper part, material in its interior and behind the device.

WARNING! The device must not be used as a supporting construction - it cannot keep the weight of the fireplace wall.

WARNING! If the device is built into the floor (only in the case of natural gas), you must take into account the minimum distance from flammable material floor finish. It is prohibited to build in LPG-powered device into the floor.

WARNING! You should follow the recommended minimum dimensions of the housing.

During construction of fireplace housing, you should consider the following:

- Inspection hatch must be placed as low as possible.
- Location of outlet ventilation holes. In order to ensure proper heat dissipation around the device, adequate space must be ensured. Fireplace wall should be properly ventilated with use of circulation holes (inlet and outlet). Outlet channels, which should be placed as high as possible on both sides of the walls of the housing (or one placed in the center) should have a total area of 300 cm² minimum, and inlet holes at the base of the wall should have a total area of 300 cm² minimum (Section 5.6.1).
- Keep at least 300 mm distance between the upper circular hole (outlet) and the ceiling of the room.
- Front hole of the fireplace housing must allow easy installation and removal of the front glass after placing the fireplace wall.
- Secure the gas assembly and gas pipes against cement and mortar.
- Decorative strips, frames, etc. should be installed after the completion of all required structural work, if possible. You should avoid using masking tape. If this is not possible, you should use good quality masking tape and remove it immediately after completion of the work including plastering or painting.
- Do not apply the plaster directly on the mounting frame nor on the edges, because the high temperatures generated by the device can cause cracks and it may not be possible to assembly or disassembly of the front glass.
- In case of using stone materials and/or gypsum plasters, to prevent the occurrence of cracks, leave fireplace wall to dry for at least six weeks before putting the unit into service.

WARNING! Before closing the fireplace wall completely, please ensure that:

- Concentric flue system has been placed correctly.
- Channels, mounting brackets and any connecting terminals, which will not be available after installation, are mounted correctly by using self-tapping screws.

5.6.1. Installation of the Monroe Single Sided

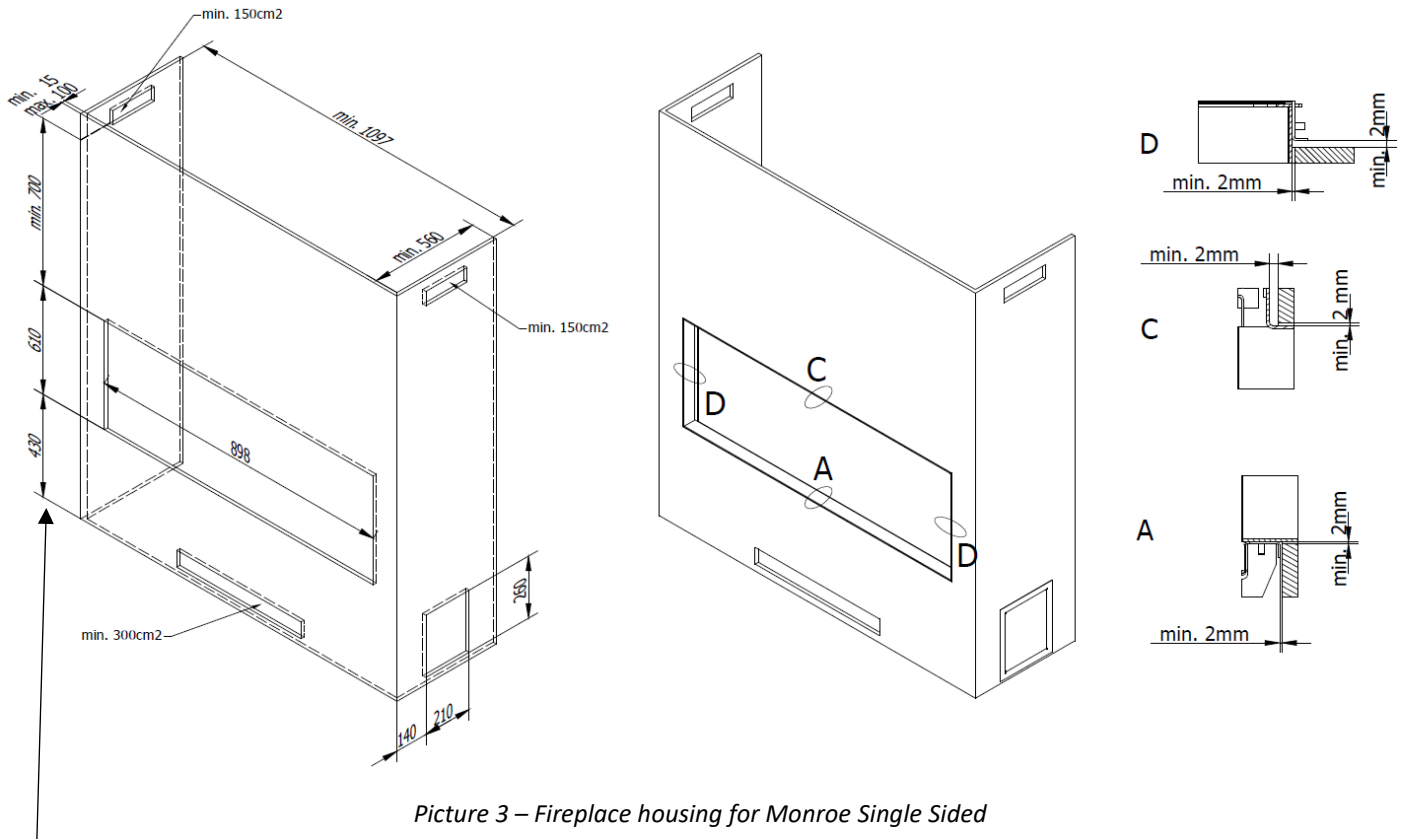

Picture 3 – Fireplace housing for Monroe Single Sided

WARNING! The minimum height for the location of the inspection hatch beneath the product is 430mm. In case of the location of the inspection hatch next to the product, the height is minimum 215mm.

5.6.2. Installation of the Monroe Left / Right Corner

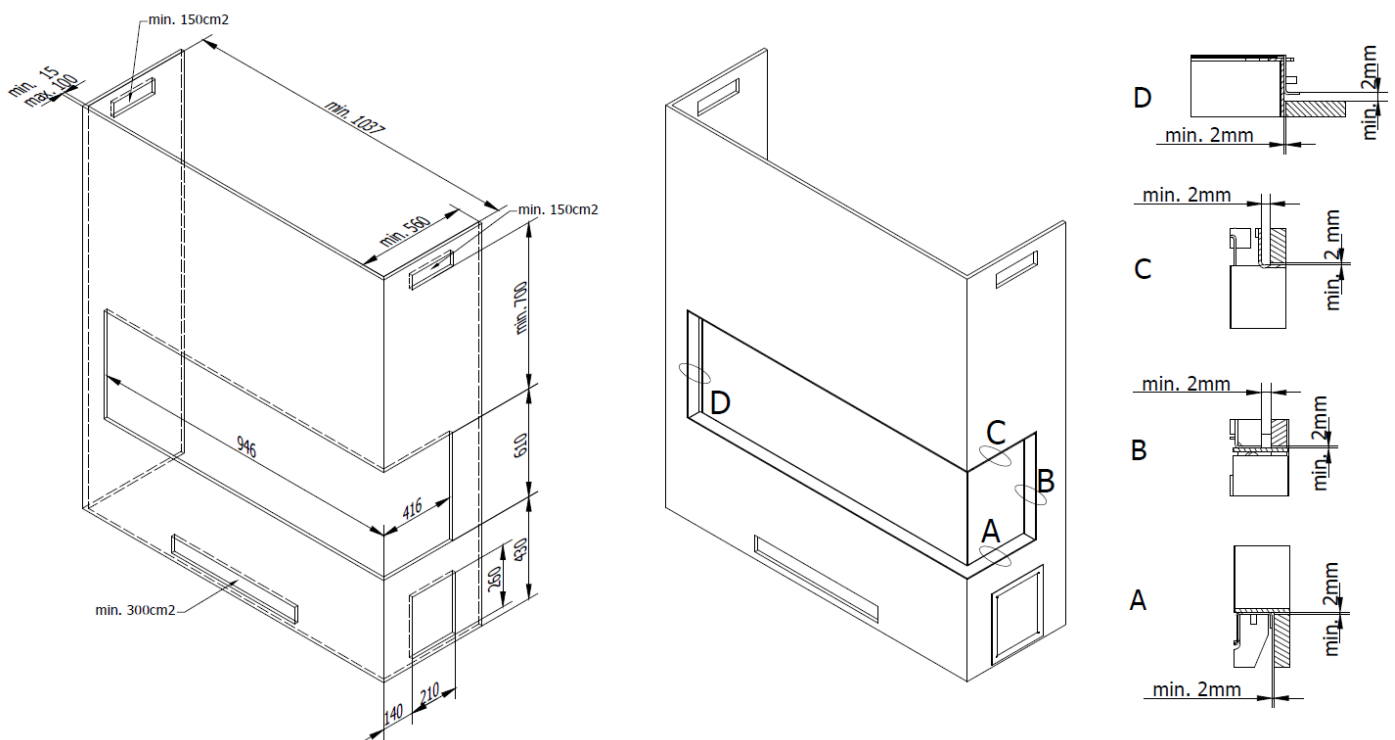

Picture 4 – Fireplace housing for Monroe Left / Right Corner

5.6.3. Installation of the Monroe Three- Sided

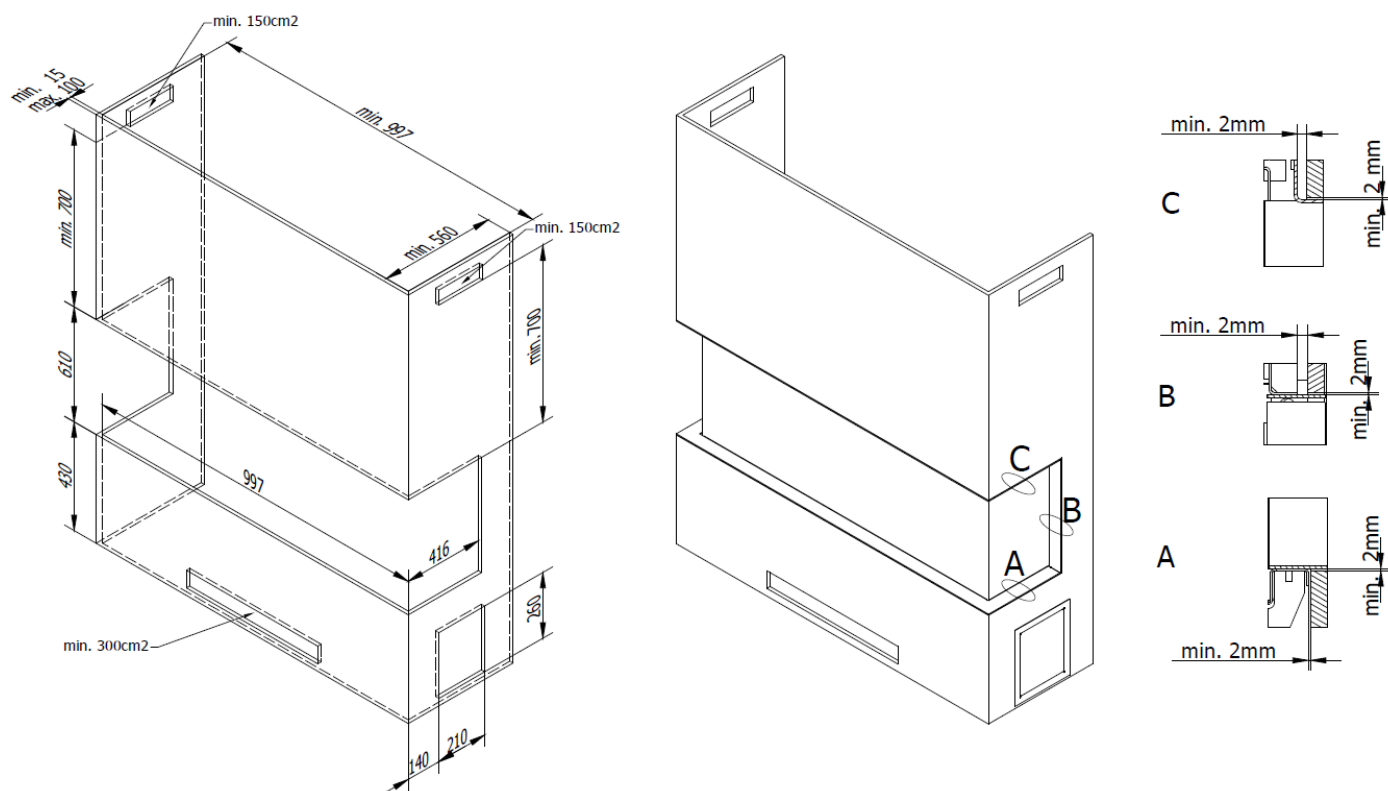

Picture 5 – Fireplace housing for Monroe Three Sided

5.7. Fireplace housing with platform

The device can be installed with the platform, being horizontal part of the housing, placed in front of the glass of the device. You can do this in combination with the bottom decorative frame or in the form of adjacent to the glazing.

WARNING! The horizontal surface located in front of the glazing must be constructed of non-flammable and heat-resistant material.

5.7.1. Fireplace housing in combination with bottom decorative frame

- You must follow the correct notch in the horizontal parts of the installation according to the drawings below.
- Adjust each other height of the device with decorative frame and mounting kit (constructive elements), so that the upper part of the platform is connected with the lower part of the bottom decorative frame.
- You cannot allow the platform weight to rest on the device. To do this, use the appropriate mounting kit (e.g. frame made of aluminum profiles).

Fireplace with two-sided glazing

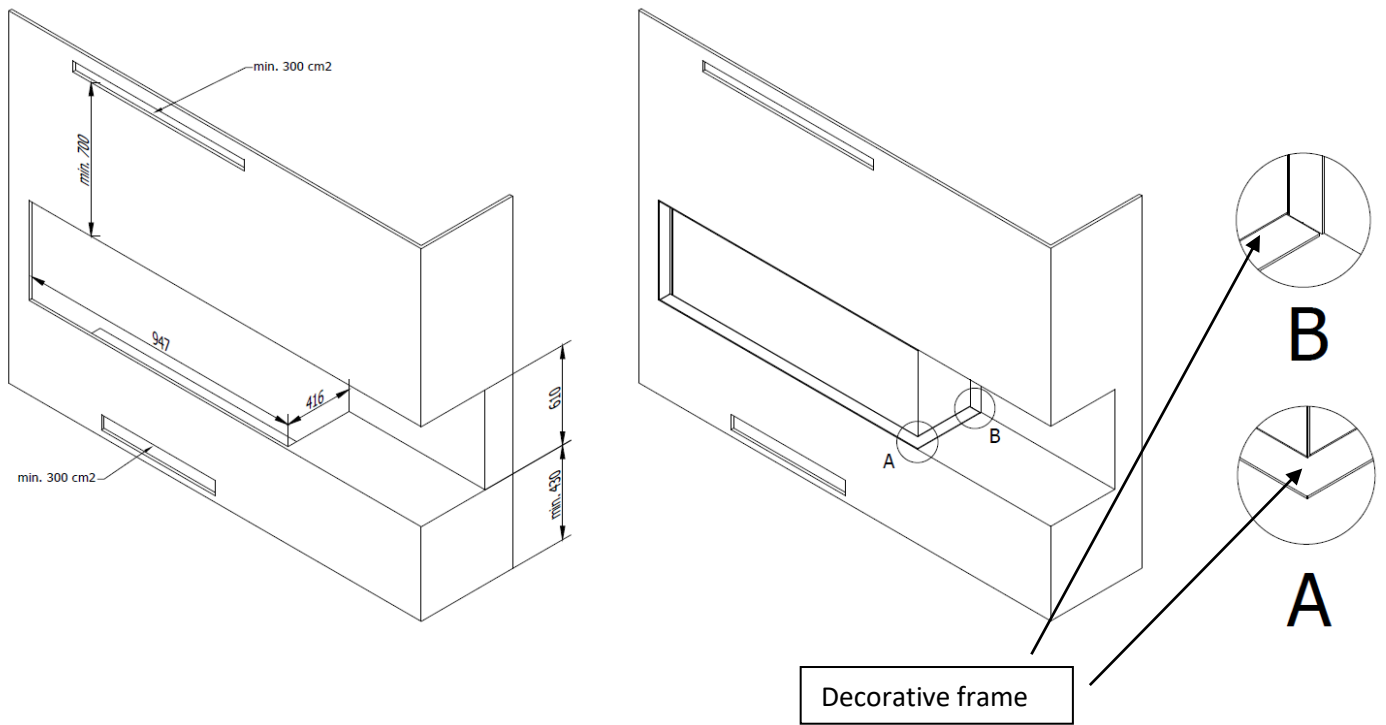

Picture 6 – Fireplace with decorative frame

Fireplace with tripartite glazing

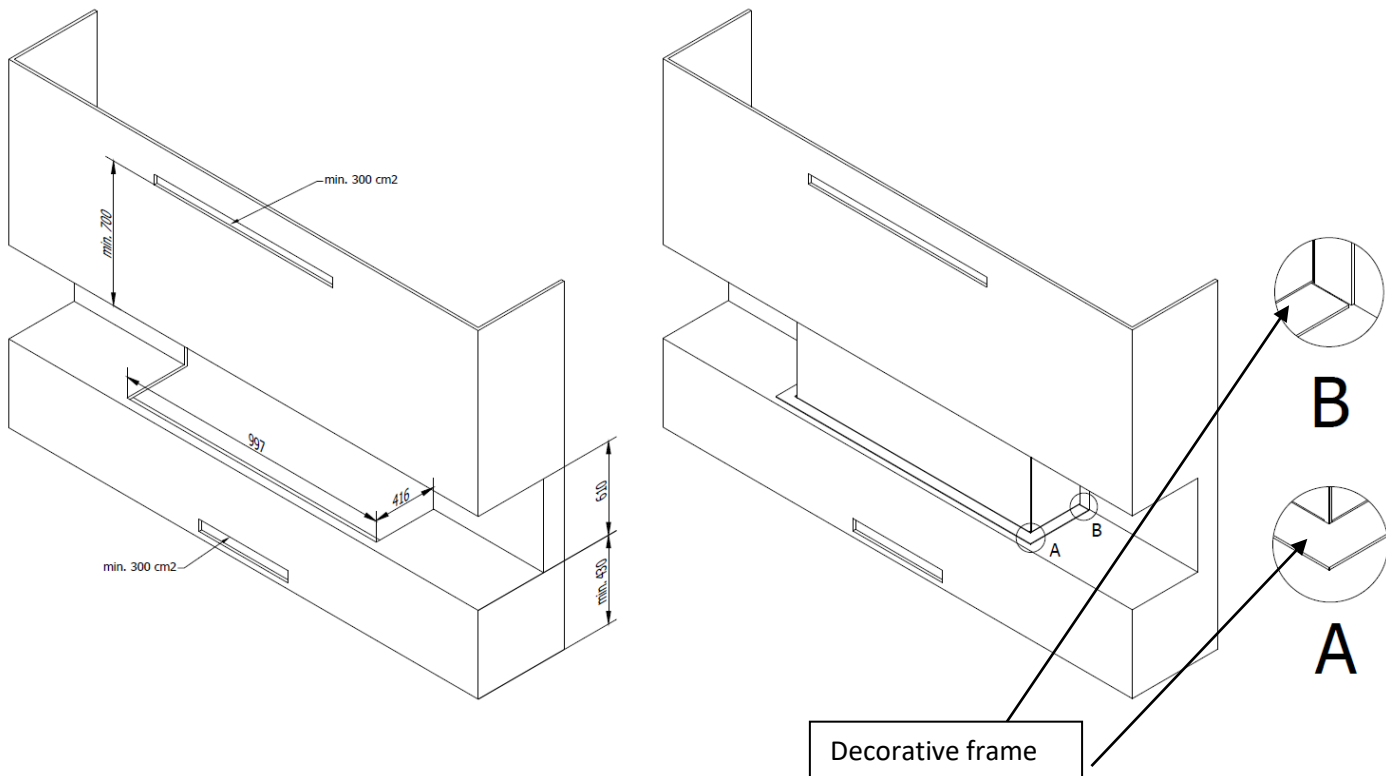

Picture 6 – Fireplace with decorative frame

5.7.2. Fireplace housing without decorative frame

Design of the device allows the installation of the front lower part of the fireplace housing without decorative frame. This is allowed thanks to the installation of the horizontal part of the fireplace housing constructed of non-combustible and heat-resistant material near the machine shaft with a maximum material thickness of 30 mm. To properly construct fireplace housing, you should pay attention to make appropriate cut in the horizontal part of the fireplace housing according to the drawings below.

Fireplace with two-sided glazing

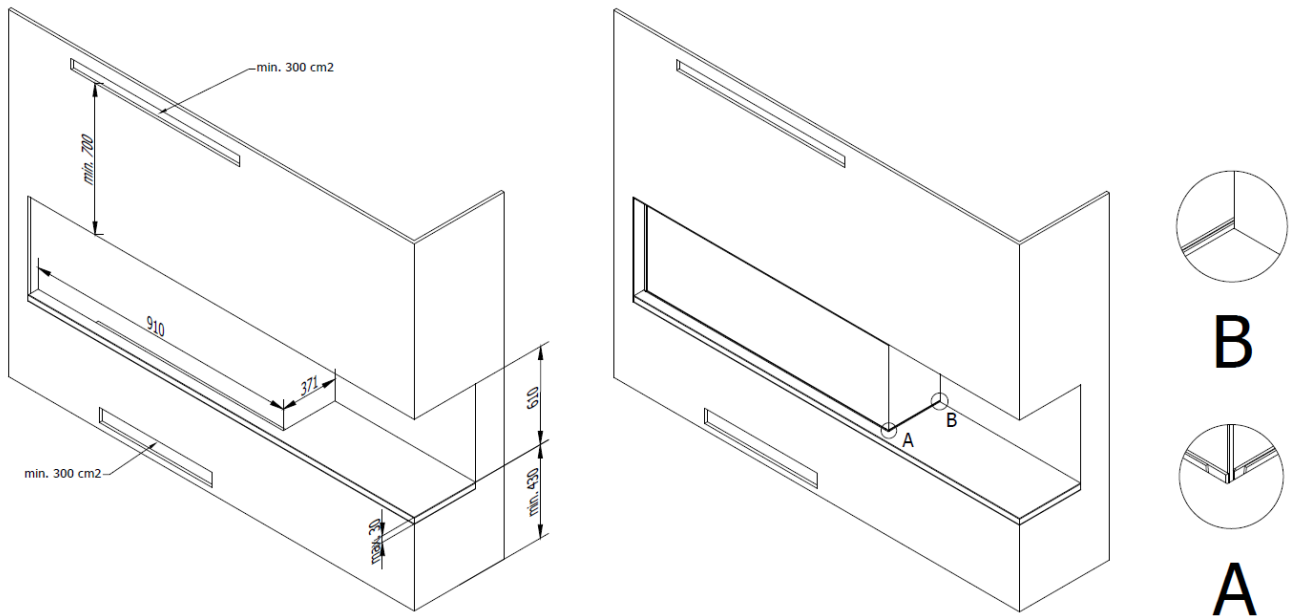

Picture 7 – Fireplace without decorative frame

Fireplace with tripartite glazing

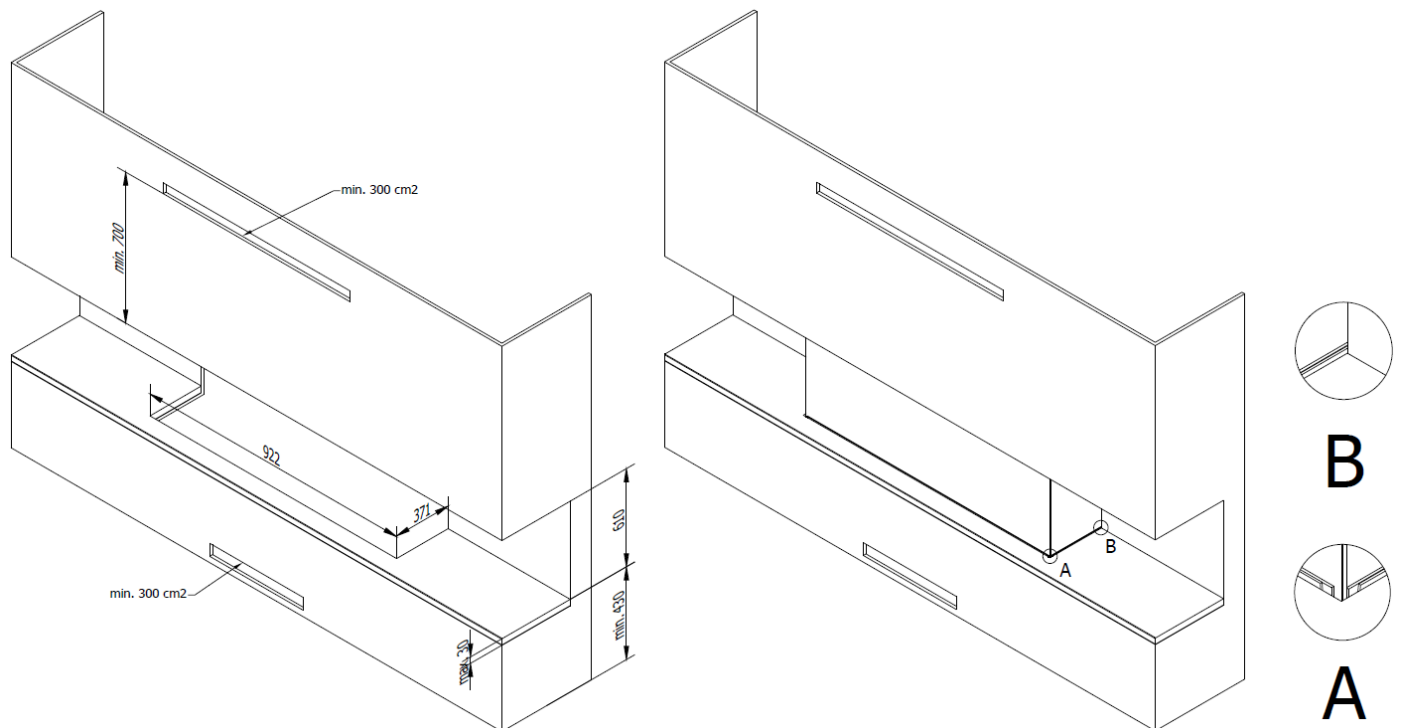

Picture 8 – Fireplace without decorative frame

To remove the lower decorative frame you should:

- Loosen the nut M6 (A) on the bottom of the decorative frame.
- Dismantle and remove bottom decorative frame (B) from the bracket by careful lifting and bringing it forward. In this housing variant, the frame will not be re-installed.
- Loosen the brackets of the decorative frame (D) by unscrewing a few turns M6 nuts (C) on the body of the fireplace, which allows you to set the correct location of the frame in relation to the finishing material of the housing.
- Set brackets of decorative frame (D) at the correct height. It depends on the thickness of the material, which the fireplace housing is made of. In the lower part of the bracket there are notches (E), i.e. indicating the standard thickness: 20mm and 30mm. Setting a notch on a par with the edge of the body of the fireplace provides a horizontal position of the bracket. In order to ensure correct adjustment of the brackets, you must use the level.
- Tighten the nuts M6 (C).
- Adjust the height of each unit and installation kit (fireplace housing components), so that the lower part of the housing is connected with the adjustable brackets.
- **WARNING!** We cannot allow the fact that the burden of fireplace housing rests on the device or on a regulated profile. Make sure that there is enough space for the purpose of assembling and disassembling the front glass. Keep a minimum distance of 5 mm from the edge of the horizontal fireplace housing and the vertical surface of the front glass.
- **WARNING!** The platform shall be constructed of non-flammable and heat-resistant material.

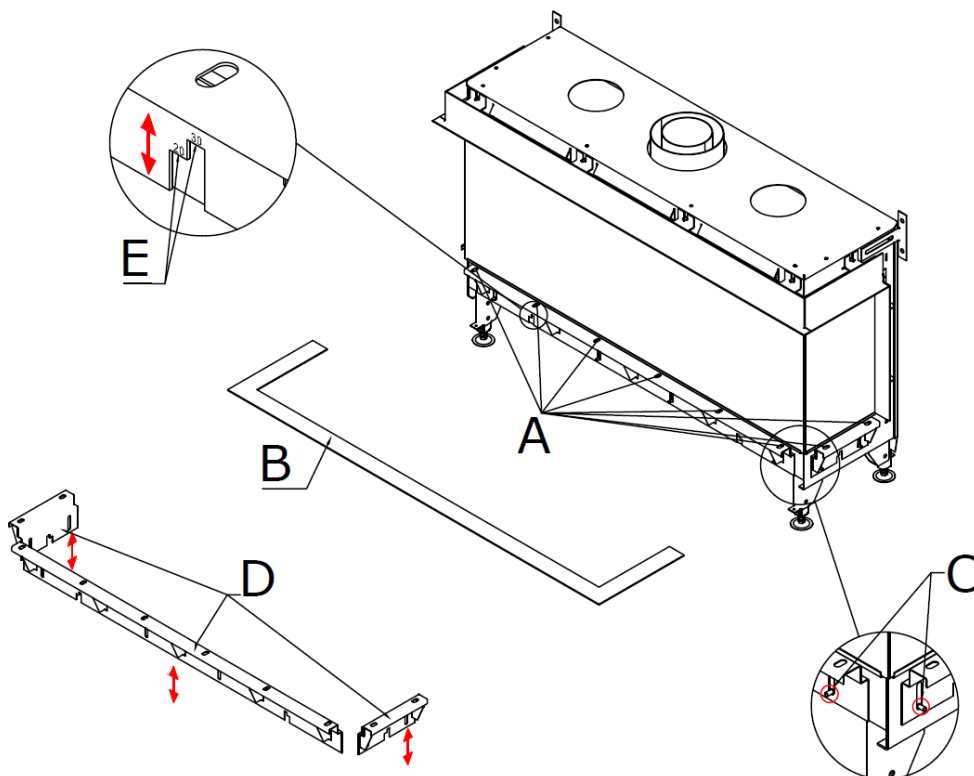

Picture 9 - Disassembly of the lower decorative frame

5.7.3. Adjustment of the upper decorative frame

In order to adapt the fireplace and its housing to the customer's needs and provide the optimal vision of the flames on the furnace, it is possible to adjust the position of the fireplace's top decorative frame in the range from 0 to 40mm (comparing to the default assembly)

To change the position of the upper decorative frame of the fireplace you should:

- Loosen all nuts that press the frame to the fireplace body
- Position and level the frame at a fixed height.
- Tighten all nuts that press the frame to the fireplace body
- **WARNING!** Take care that the frame does not slip down in an uncontrolled way and damaging eg the front glass of the fireplace.

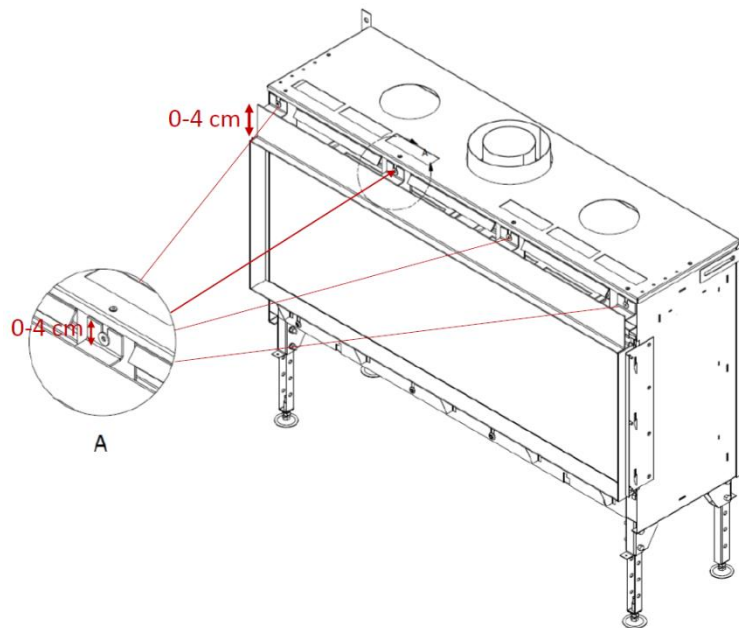

Picture 10 - Adjusting of the upper decorative frame

5.8. Placing the inspection hatch

The fireplace must be installed with the inspection hatch supplied with the unit. This is necessary in order to ensure sustainable, safe and correct operation and also facilitates free access to the block of the gas assembly during service and maintenance. During transport, the gas assembly is attached to the metal body of the device. It should be removed and placed in the inspection hatch during installation. Inspection hatch should be placed as low as possible in the wall of the fireplace housing. The lower part of the inspection hatch could not reach higher than the surface of the burner of the device. Inspection hatch should be placed only inside dry room.

To place an inspection hatch in the wall of the fireplace, you should make a hole in it with dimensions of 205x255 mm, which can be made in horizontal or vertical position. Place an inspection hatch in this hole, together with gas assembly.

In order to mount the gas assembly inside the inspection hatch you should:

- Remove the handle with the gas assembly components (B - Picture 11) from the fireplace casing from a temporary location for the duration of the transport.

- Unroll the ignition cables and ionization electrode cable. This will prevent, among other things, poor operation of ignition. Be sure not to lead the ionization electrode cables and ignition electrodes next to the metal parts.
- Unroll flexible metal gas hoses, not allowing the formation of hose kinks.
- Install inspection hatch in this hole in the wall of the fireplace housing according to the previously mentioned guidelines.
- Mount the handle with the gas assembly components (B - Picture 11) to the bracket (C - Picture 11) in the internal frame of inspection hatch (A - Picture 11).

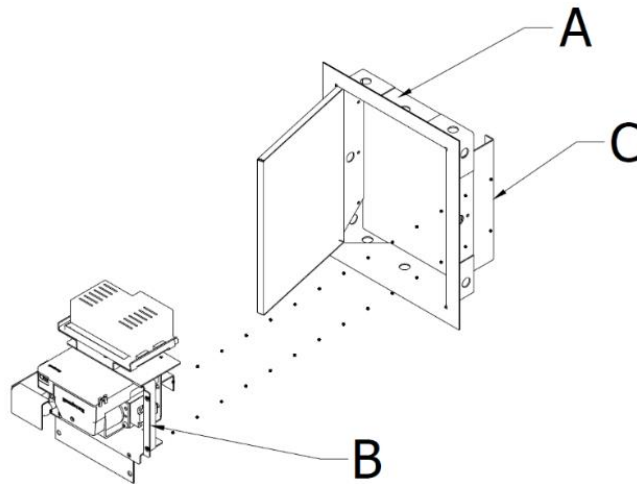

Picture 11-Installation of the gas assembly in the inspection hatch

- Attach the handle with the gas assembly components (B - see Picture 11) using self-drilling screws.
- Make sure that in there is no dirt in the gas pipes as well as connections at the gas assembly.
- Connect the gas pipe to the gas assembly.
- Connect the mains voltage 230 V with grounding to the power cord ended with cube, running from the gas assembly. **WARNING!** Connecting the device to the electrical network can be performed only by the person with the appropriate permissions.
- When placing the inspection hatch with gas assembly, the minimum size necessary for proper and safe installation should be considered.

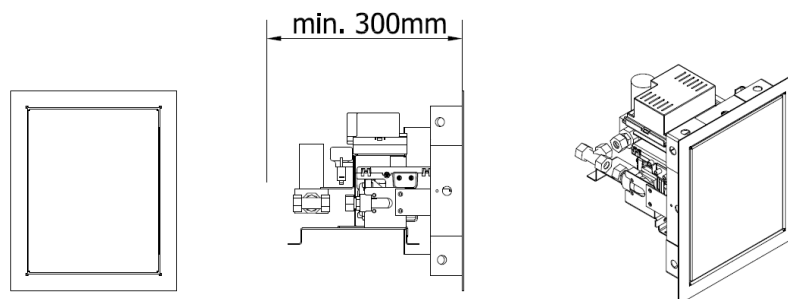

Picture 12 - The minimum size for gas assembly installation needs

- Pay attention to the maximum distance of the gas assembly from the fireplace when placing the inspection hatch with a gas assembly.

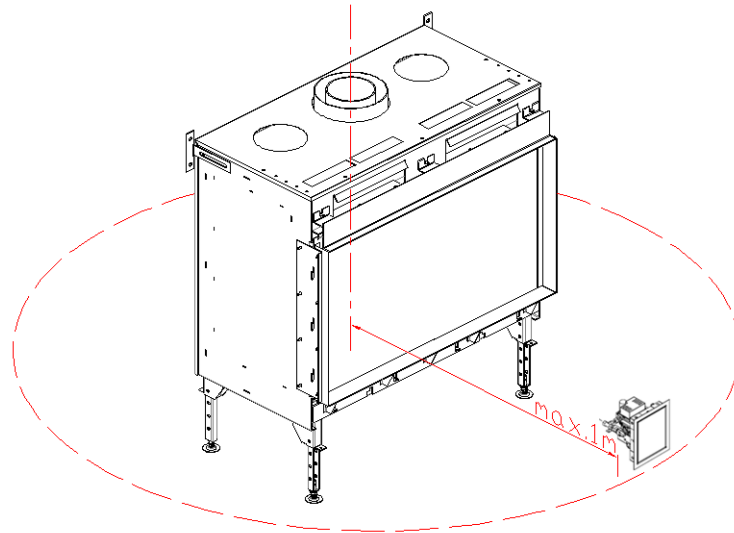

Picture 13 - Maximum distance of the inspection hatch with gas assembly from the fireplace.

5.9. The exhaust and combustion air supply system

5.9.1. General Information

The device is connected to the integrated exhaust and combustion air supply system, hereinafter referred to as concentric flue system with dimensions of 200mm / 130mm. The concentric flue system might be derived outside by the side wall of the building as well as the roof. If necessary, you can also use the existing chimney for the combustion air supply. concentric flue system is designed for indoor use and therefore cannot be used outside, with the exception of terminals that are made for this purpose. In all these cases you must comply with regulations in force in the country.

Use the concentric system supplied by Planika. This system has been tested in conjunction with MONROE series.

WARNING! Planika company cannot guarantee the proper and safe operation of other concentric systems, than provided by the manufacturer, and therefore disclaims any responsibility for malfunction of the system, which may result in incorrect operation of the device MONROE, its damage and violation of generally understood principles of safety.

Installation of concentric flue system should start from the connection of the device with installed on the factory adaptor. If, however, in connection with the mounting conditions, concentric flue system was installed in the first place, before the proper placement of the device, the concentric system can be connected to the device using a telescopic element of the concentric tubes.

Maximum length of the concentric flue system should not exceed 12 meters. It should be remembered that the 90 ° elbow is converted as a section of 2 meters, while the 45 ° elbow corresponds to the amount the concentric section with a length of 1 meter. It is recommended to exit the concentric flue system through the wall of the building by the use of 1 meter vertical section (minimum length), elbows 90 ° and up to 5 meter horizontal section (not counting the wall terminal).

WARNING!!! On the connections of individual components of the air combustion system, use supplied with the concentric flue system metal clamp providing additional rigidity of the entire system which operates in underpressure.

5.9.2. Recommendations for proper installation of the concentric flue system

To install concentric flue system you should:

- Construct the system starting from the device with mounted adapter.
- Perform passage for the needs of concentric flue system with the following diameters:
 - Pipe diameter + 50 mm for the purpose of passage through non-combustible material.
 - Pipe diameter + 200 mm for the purpose of passage through combustible material.
- Connect the straight sections and elbows (45 and 90 degree) of the concentric flue system.
- To improve the rigidity of the system you must install clumps at each connection.
- Use the appropriate number of wall brackets (every 2 meters) so the weight of the pipe does not rest on the device.
- Place the terminal seam (grooved/ribbed) to the top with a slope of 1 cm/meter towards the outside in order to prevent rainwater coming into its interior.

WARNING! Detailed installation manual of the concentric flue system is supplied together with this system.

5.9.3. Construction of the concentric flue system

Correctly installed and configured concentric flue system by the Installer will ensure an optimized air circulation inside the device and provide the best image of the flame.

In case of output of the concentric flue system through the side wall (type C11), the following requirements apply:

- Install the system in accordance with the applicable regulations, taking into account all the difficulties related to the wind pressure on the terminal.
- Drill holes of the correct diameter in the walls/ceilings through which concentric flue system will be passing. The remaining space should be supplemented by additional protective insulation against the ingress of moisture into the building.
- If the concentric flue system is located near the combustible walls (elements) you must ensure a minimum distance of 100 mm from flammable materials.
- Installation of the concentric flue system should always start with the one meter vertical section (minimum height) at the outlet of the device.
- Total height of the pipe in vertical position, in case of concentric flue system getting through the wall of the building, may not exceed a maximum length of 4 m.
- Total length of the pipe in horizontal position, in case of concentric flue system getting through the wall of the building, may not exceed a maximum length of 5 m (not including terminal).
- **WARNING!** For the insert using LPG, it is recommended to use up to 2 meter of horizontal section (not including terminal).

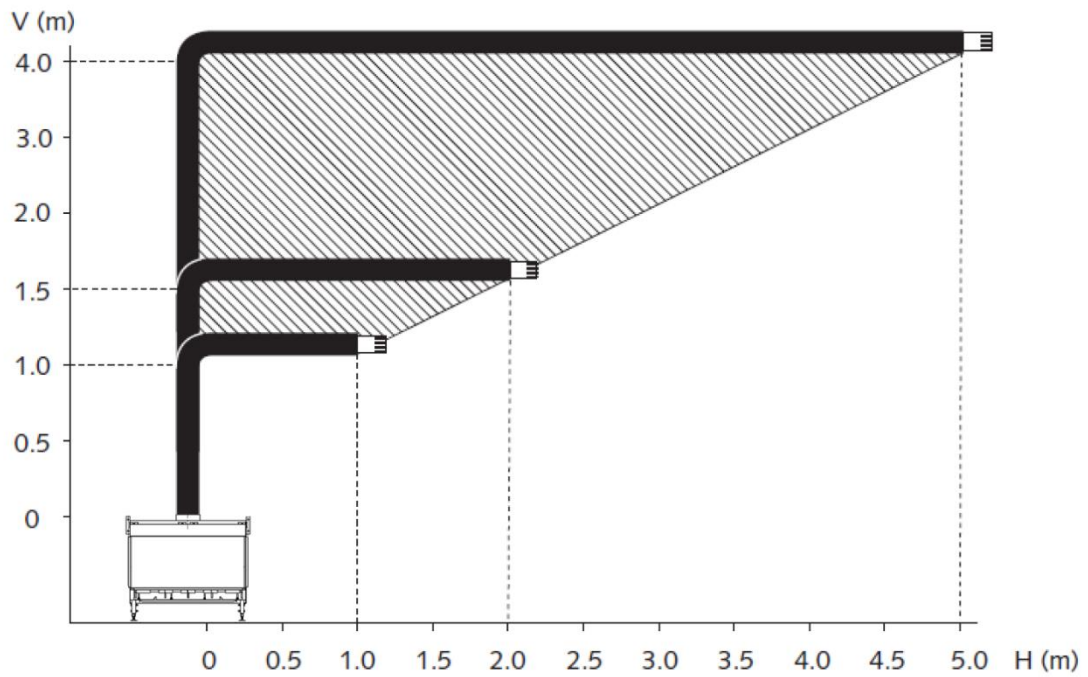

Picture 14 – Possible system configurations with the wall terminal

- The elements of the system should be connected together by using special clamps supplied with the combustion air system, which provide additional rigidity.
- If necessary, the individual elements of the concentric flue system can be stabilized by using wall brackets.

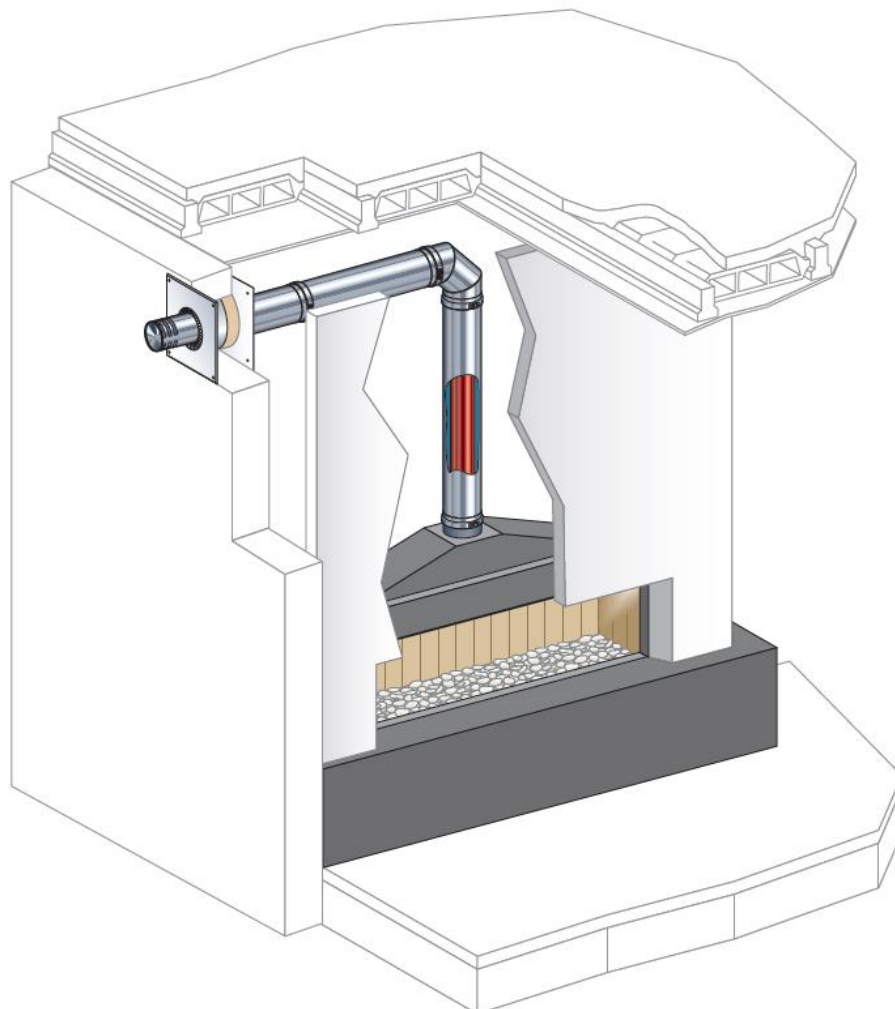

Picture 15 - Example of system configuration with wall terminal

In case of exit of the concentric flue system through the roof (type C31), the following requirements apply:

- Make the openings of the correct diameter in the walls/ceilings, which the combustion air system will be passing through. The remaining space should be supplemented by additional protective insulation against the ingress of moisture into the building.
- If the air combustion system is located near the combustible walls (elements), you must ensure a minimum distance of 100 mm from flammable materials.
- Assembly of the concentric flue system should begin with the installation of one meter vertical section (minimum height) at the outlet of the device.
- Maximum length of the concentric flue system must not exceed 12 meters
- The maximum number of bends at an angle of 90 ° cannot be higher than 4.
- To calculate the maximum length of vertical and horizontal sections of concentric flue system, you must first count the number of planned arches 45 ° and 90 °. Next, calculate the length of concentric flue system corresponding to the number of applied arches, bearing in mind that the elbow 90 ° is converted as 2 meters long section while the 45 ° bend corresponds to the concentric section with a length of 1 meter. The result is subtracted from the number 12, will inform you about the maximum total length of vertical and horizontal sections of the flue.
- The various elements of the concentric flue system should be joined together by special clamps for added rigidity.
- If necessary, the individual elements of the concentric flue system can be stabilized by wall brackets.

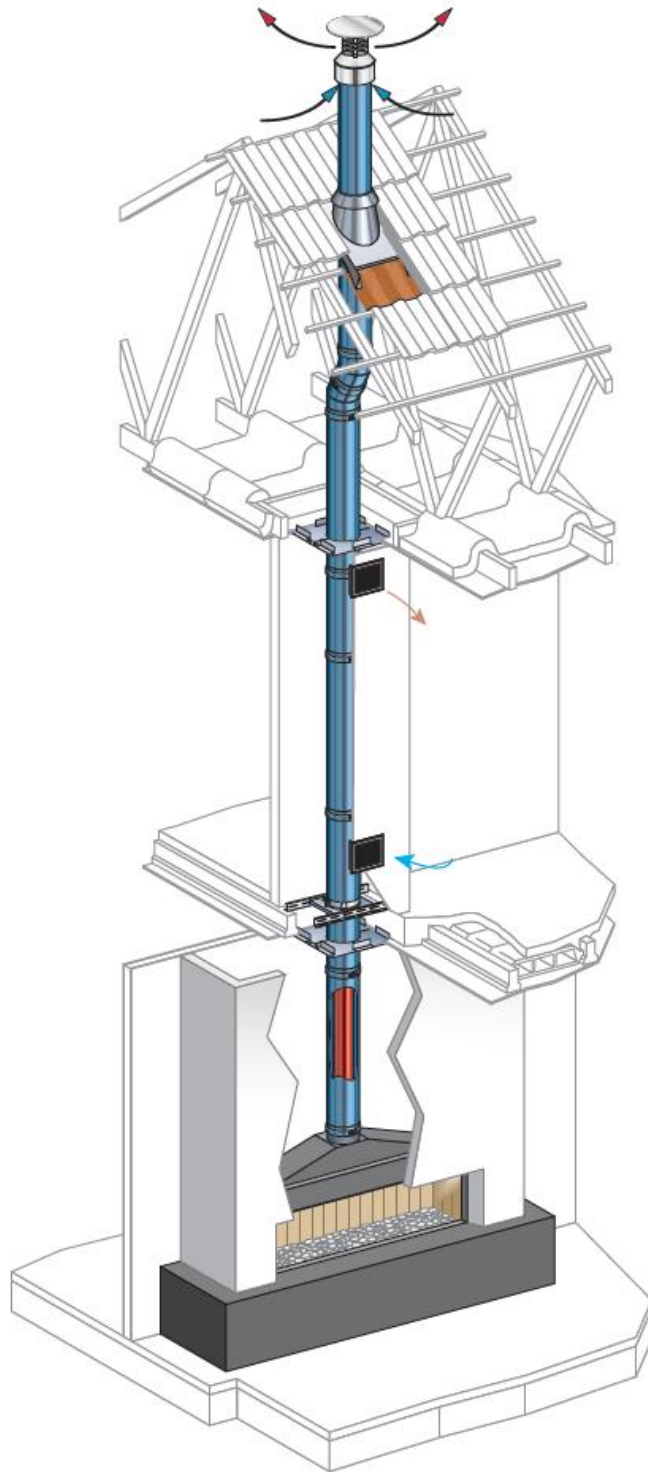

Picture 16 - Example of system configuration with roof terminal

WARNING! Along with the device, a flue gas restrictor is delivered which shall be placed in the flue pipe to adjust the chimney draft at the optimum level and to ensure the best image and behavior of the flames.

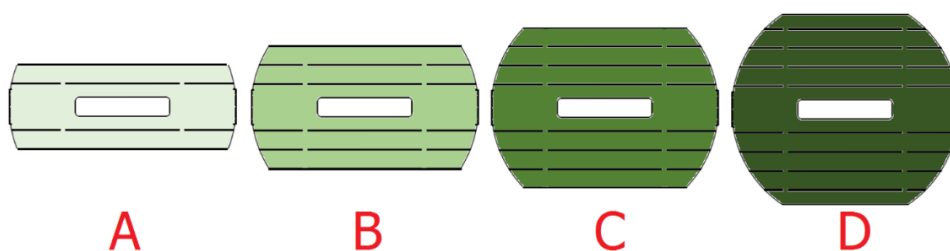

Picture 17 – Gas restrictor

In case of using a roof terminal, installation of the concentric flue system must comply with the above calculations and must be constructed according to the permissible configurations contained in the Table below.

WARNING! Please note that the following configurations are theoretical calculations and after each installation, check the chimney draft and the appearance of the flame individually for each installation. The necessity of any configuration changes may be due to the specificity of the geographical location of the fireplace installation, weather conditions, wind directions and strength and the presence of other buildings in the area.

Quantity of 90 degree Bends	Total number of meters horizontal pipe length	Total number of meters vertical pipe length											
		1	2	3	4	5	6	7	8	9	10	11	12
0 bends	0	B	B	B	C	C	C	C	C	D	D	D	D
2 bends	0	A	A	B	B	B	C	C	C	C	C	D	D
	1		A	A	B	B	B	C	C	C	C	C	
	2			A	A	B	B	B	C	C	C		
	3				A	A	B	B	B	C			
	4					A	A	B	B				
4 bends	0	A	A	A	A	B	B	B	C	C	C	C	C
	1		A	A	A	A	B	B	B	C	C	C	
	2			A	A	A	A	B	B	B	C		
	3				A	A	A	A	B	B			
	4					A	A	A	A				

Table 1 - Concentric flue system configuration with a roof terminal

WARNING! The above configuration Table is also applicable in the case of connection of the fireplace to an existing chimney.

A properly selected flue gas restrictor should be placed during the installation of the fireplace before connecting the concentric flue system. It should be installed in the exhaust pipe (internal) in specially designed brackets.

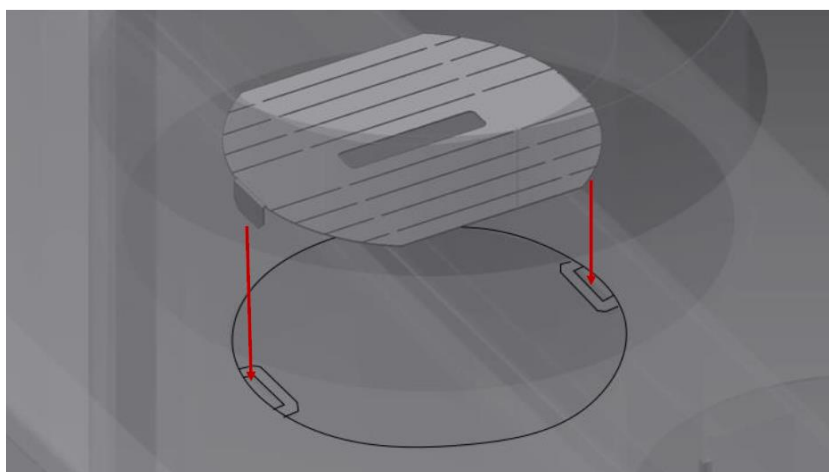

Picture 18 – Gas restrictor attachment

If it is necessary to change the configuration of the selected flue gas restrictor after the installation of the fireplace and after the final installation of concentric flue system, access to it is only possible through the fireplace combustion chamber.

In such a case to replace the flue gas restrictor you should:

- Disassemble the front glass of the fireplace,
- Unscrew the nuts holding the plate located in the upper part of the combustion chamber,
- Disassemble the plate,

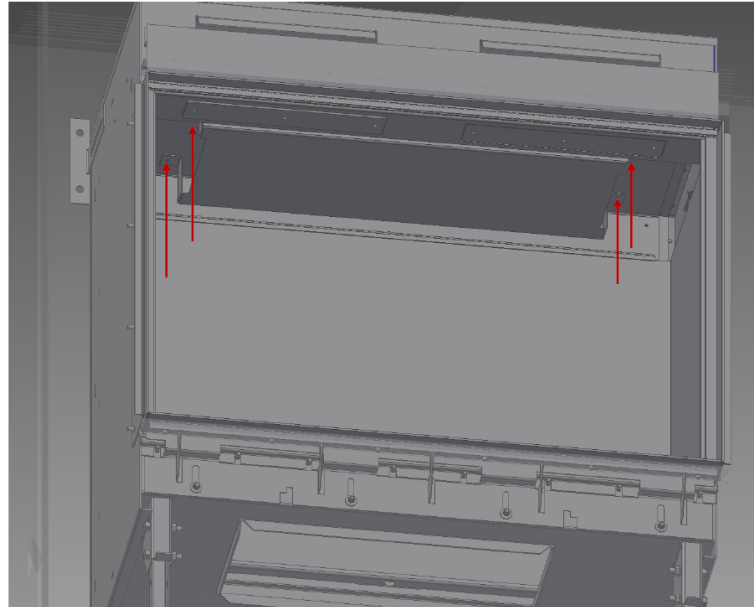

Picture 19 – Plate dissembling

- Replace the flue gas restrictor, paying special attention to place it properly in specially designed brackets.

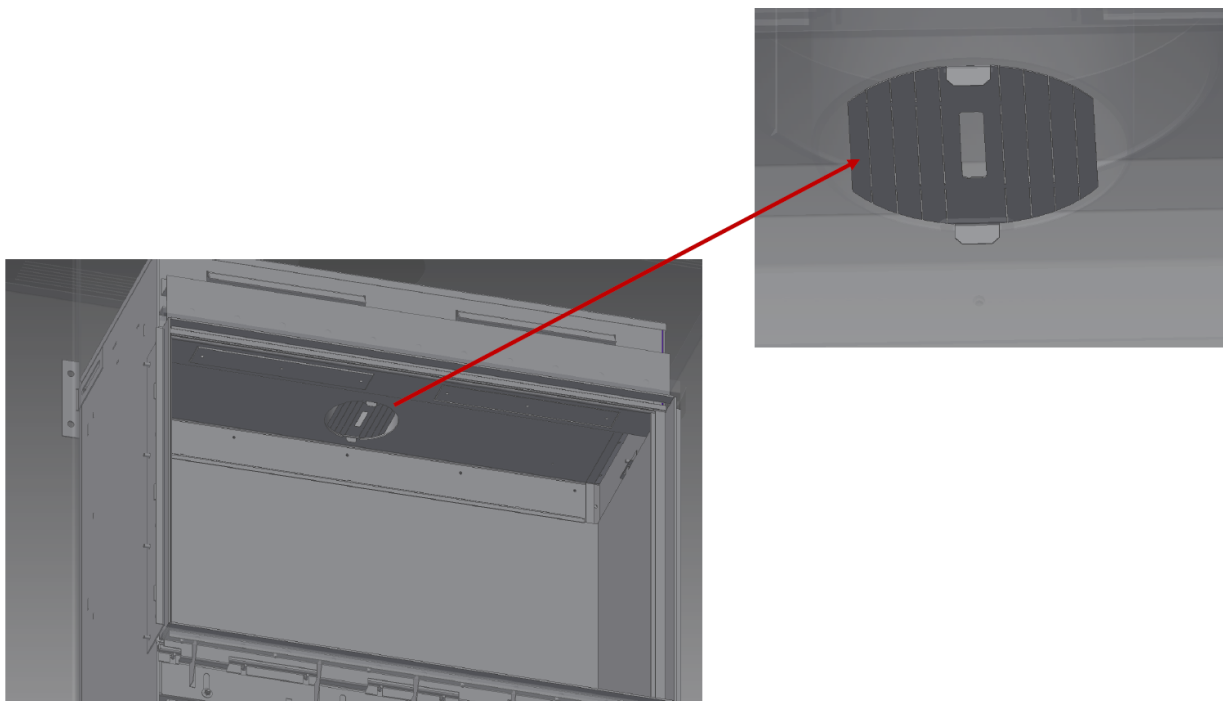

Picture 20 – Gas restrictor placing

- Mount the plate in the upper part of the combustion chamber,
- Install the front glass of the fireplace.

Connection to the existing chimney (type C91)

The device can also be connected to an existing chimney using for this purpose a flexible stainless steel tube affixed to the chimney with a diameter corresponding to the diameter of the exhaust outlet of the device for the purpose of discharging flue gases (130mm). The area around is used to supply air for combustion. Please note that the system should start from a minimum of 1 m section of the concentric flue system (200/130), only then connect it to the system inside the existing chimney.

In case of connecting to an existing chimney, the following requirements apply:

- Approved only for use in combination with a special chimney set supplied by the manufacturer.
- The internal dimension of the existing chimney should be at least 200 x 200 mm, and the vertical height should be up to 12 meters.
- The total length of the horizontal pipe must not exceed a maximum length of 4 m.
- The existing chimney should be cleaned and sealed.
- In case of installation to the fireplace housing with already existing chimney, the same guidelines and instructions apply as like in case of the device with concentric system described above.
- **WARNING!** Installation manual is supplied separately with the supplied system.

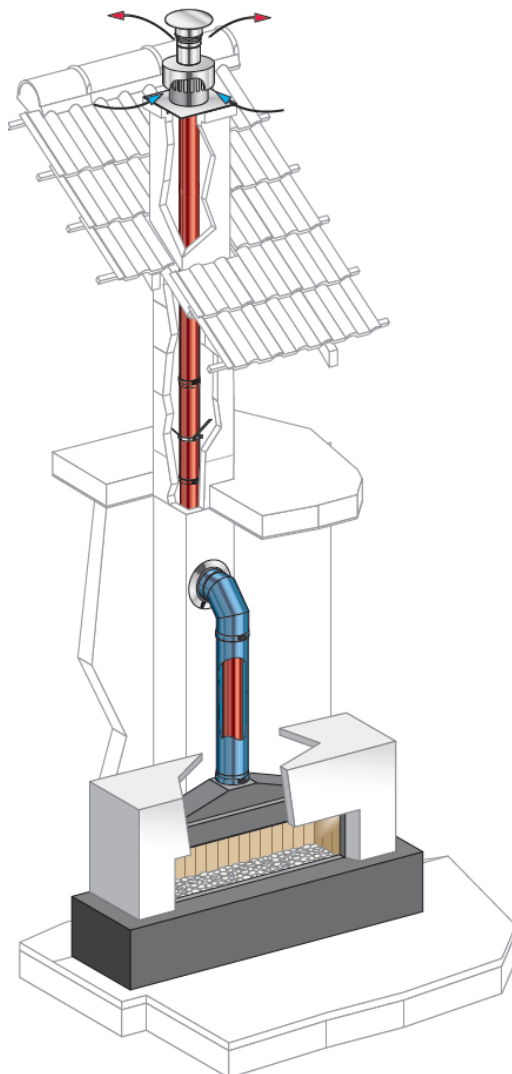

Picture 21 – Sample configuration of connecting to an existing chimney

5.9.4. Distances of the exhaust outlet from the structural elements of the building

During the design and installation of concentric flue system, you should pay special attention to the location of the exhaust outlet in relation to the structural elements of the building.

<p>Height near a roof window.</p> 	<p>Location near a roof window.</p> 
<p>Height above the ground level.</p> 	<p>Location near the door and window openings.</p> 
<p>Location under the balcony and below the edge of the roof.</p> 	<p>Location near shading projections.</p> 

Table 2 – Distances of the exhaust outlet

- The distance from the obstacles and structural elements at the roof passage.

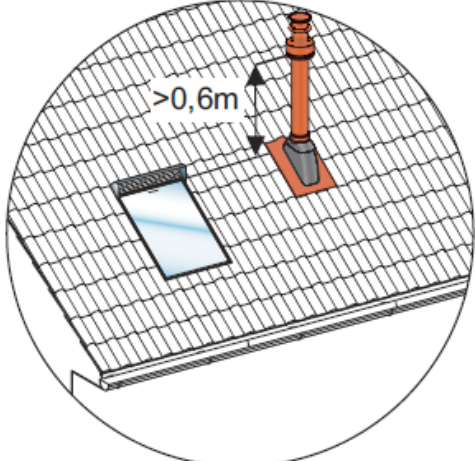
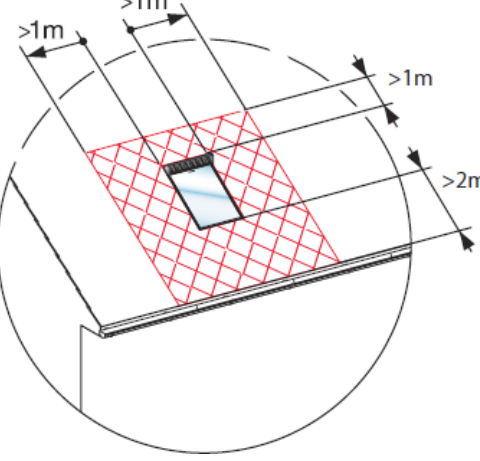
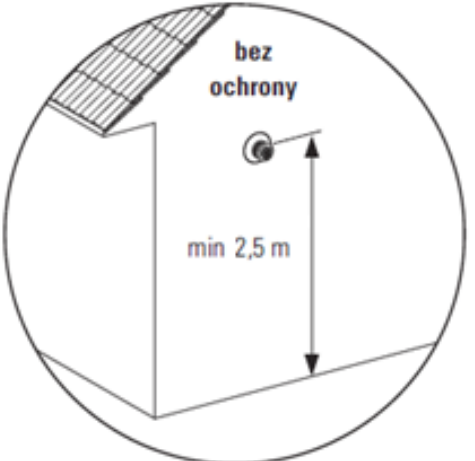
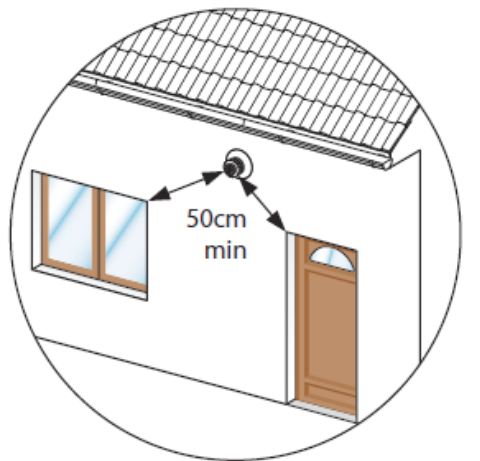
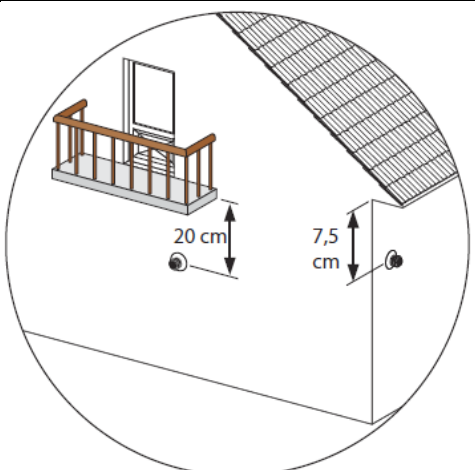
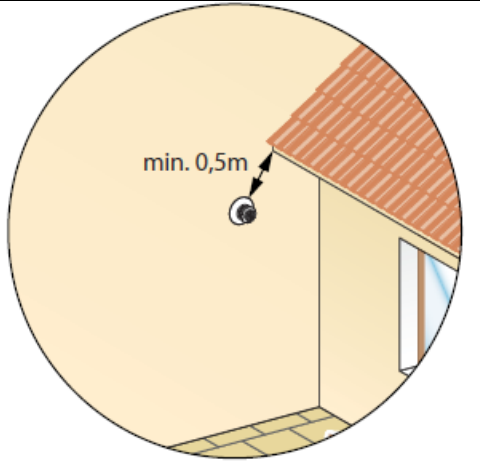
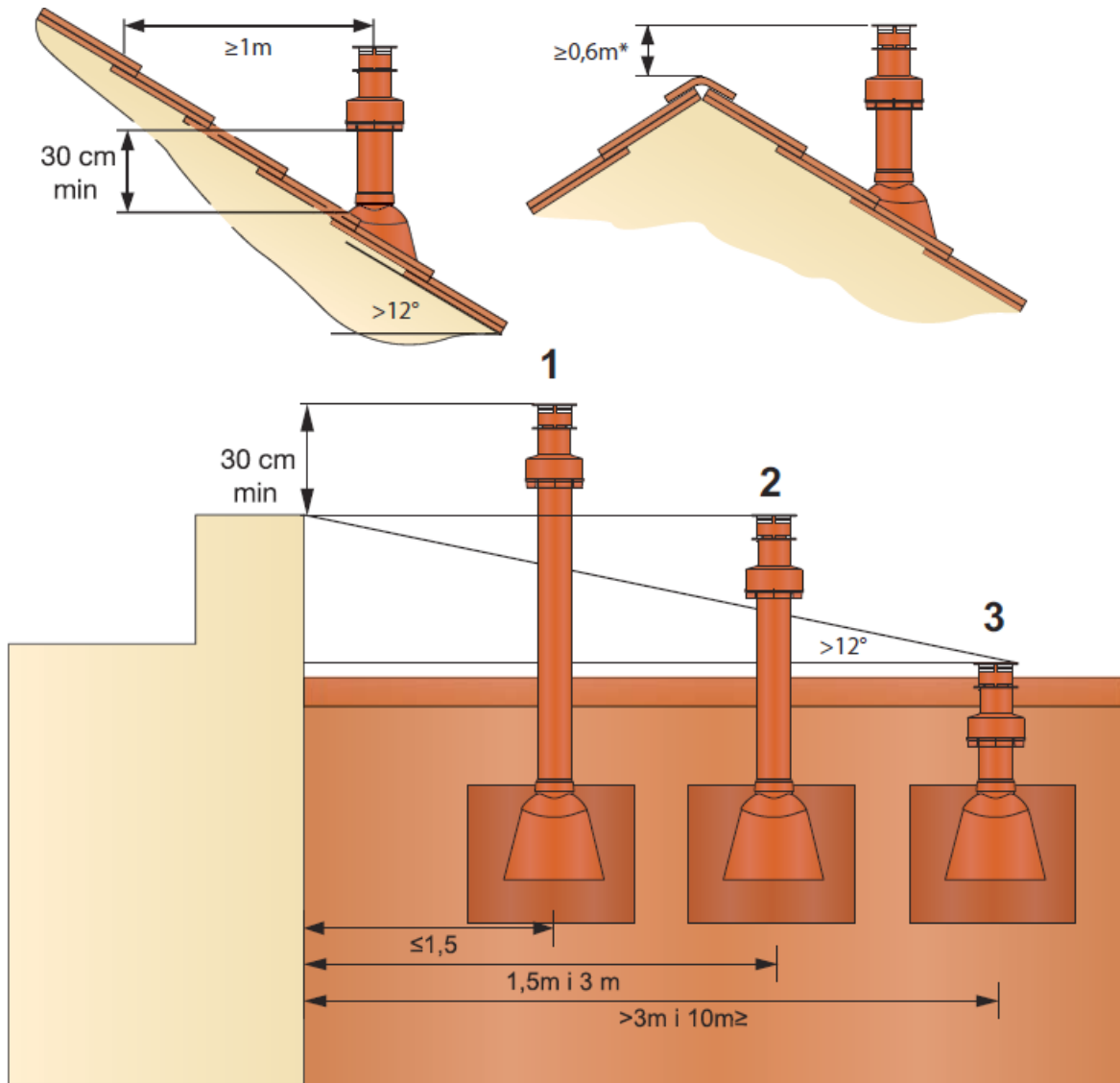

Picture 22 – Distance from the obstacles and structural elements

1. In case of exhaust outlet from concentric flue system situated at a distance of 1,5m from the obstacle, the outlet chimney must be placed 0,3m above the top edge of the obstacle.
2. In case of exhaust outlet from the concentric flue system situated at a distance of 1,5 to 3m from the obstacle, the outlet chimney must be placed at least at the level of the upper edge of the obstacle.
3. In case of exhaust outlet from the concentric flue system situated at a distance of 3 to 10 meters from the obstacle, the outlet chimney must be placed at least 0,3 m above the surface of the roof with a slope greater than 12° and at least 0,6 m above the surface of the flat roof.

5.10. Ventilation and air circulation inside the fireplace housing

- To provide adequate air circulation inside the fireplace housing, the walls of the building should be equipped with appropriate ventilation openings.

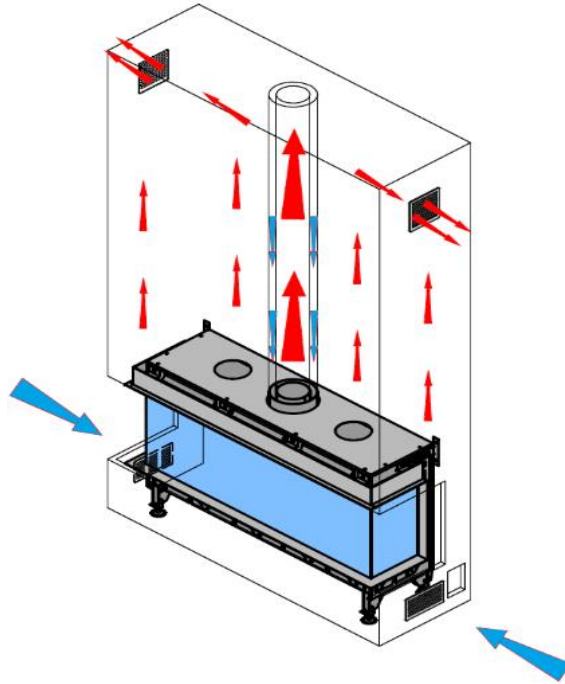

Picture 23 - Ventilation openings

- To improve the circulation inside the fireplace housing and direct the stream of hot air passing through the body of the device, you can use two openings inside the casing, located on its upper part. You should use flexible connections for this purpose to move the hot air outside the housing.
- When using the openings in the upper part of the unit, in order to distribute the hot air from the body of the fireplace, it is necessary to make them above the ventilation openings to discharge the hot air outside of the fireplace housing itself.

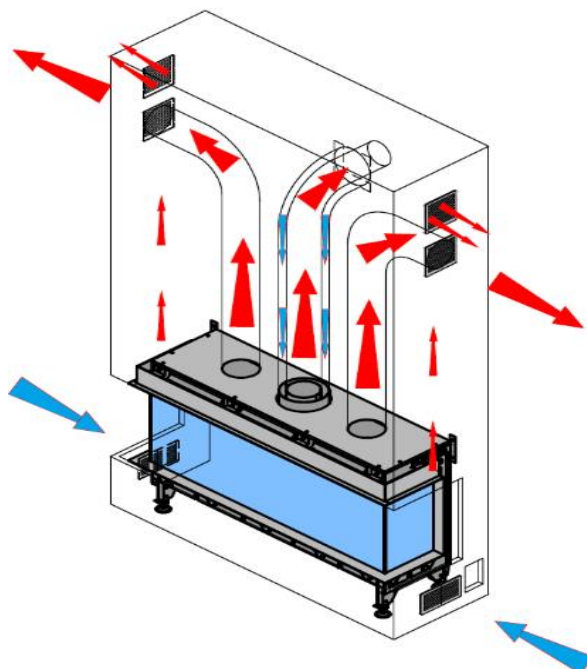

Picture 24 - Vents with use of hot air distributor

5.11. Placing decorative elements

To install decorative elements, it is necessary to dismantle the front glass. Elements should be arranged in such a way as not to obscure the ionization and ignition electrodes as well as outlets of the hearth and to allow free flow of air around the hearth. Otherwise, it may result in incorrect operation of the fireplace. The ceramic elements or decorative stones cannot adhere to the glass, as it may cause its damage.

Decorative set of filling the combustion chamber attached to the unit consists of:



Vermiculite	Vermiculite chips	Glowing wires
		

Table 3 – Vermiculite, Vermiculite Chips and glowing wires

- Set of decorative logs

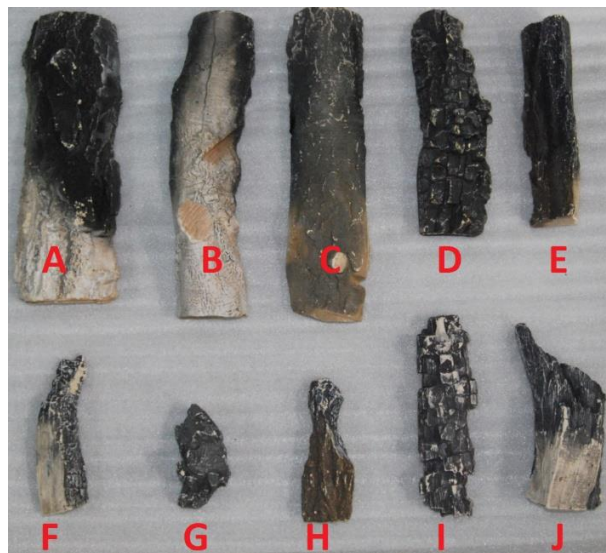

Photo 3 – Quantity of decorative elements

- Ceramic logs which will be placed on the 3 top burners have suitable recesses at their bottom part that match the shapes and sizes of burners

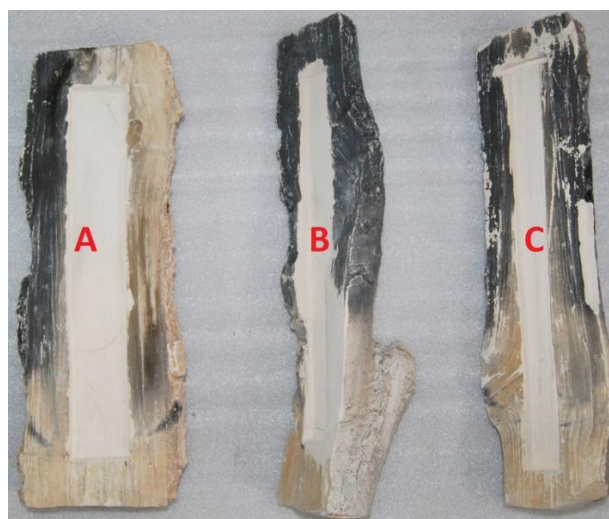

Photo 4 – Ceramic logs for top burners

WARNING! To ensure correct functioning of the device, the following safety instructions must be strictly observed:

- Do not place additional imitative blocks or glowing wires on the burner or in the combustion chamber other than those supplied with the device.
- Decorative stones must be placed according to the description and photographic documentation.
- Glowing wires should be used only in combination with decorative logs.
- Ceramic logs should be placed according to the description and photographic documentation. No other way of stacking logs is allowed other than the one indicated further in this manual.
- Decorative stones must be placed according to the description and photographic documentation. The Interior of the combustion chamber should be filled with all supplied decorative stones.
- Make sure that the ionization and ignition electrodes as well as the space around them remained free, so that no decorative element touches any of the electrodes.
- Make sure that the gap between the burner and the tray surrounding the burner is not blocked by any decorative elements.
- Make sure to avoid spilling the powdery residue from the packaging during placing the vermiculite on the burner.

5.11.1. Arranging decorative logs

To properly arrange decorative logs on the burner you should:

- Fill the burner with vermiculite that came with the device and spread it evenly over its entire surface, remembering that vermiculite cannot reach above the edge of the burner. Uneven distribution of vermiculite may adversely affect the image of the flame and the life of the burner.

WARNING! The surface of the burner should be completely covered with vermiculite, in order not to shorten the life of the burner.

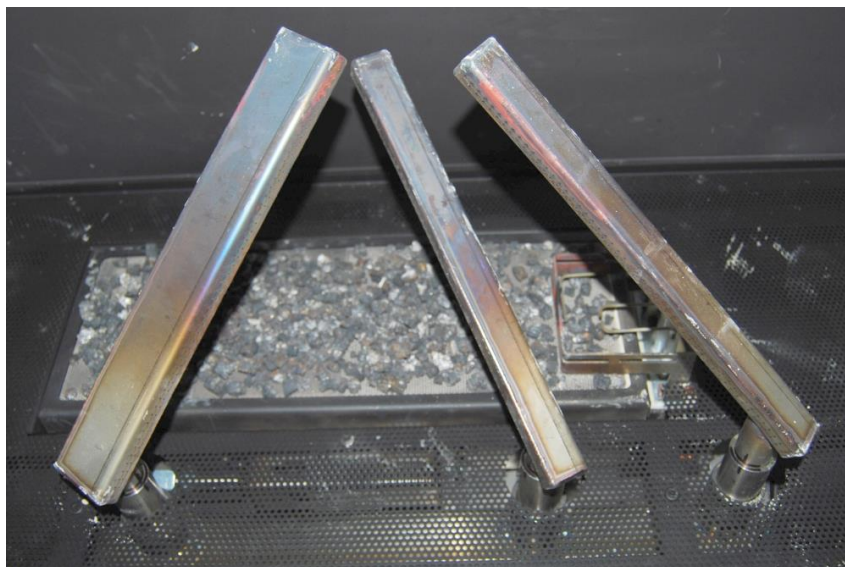

Photo 5 – Vermiculite spread on burner

- Fill the tray designed for vermiculite located around the burner with the vermiculite chips by evenly distributing them.



Photo 6 – Vermiculite chips spread around the burner

To place decorative logs on the main burner:

- Identify all the ceramic logs from D to J. During the identification, follow the traces of burns on the surface of the branches and their shape.
- Place ceramic logs on the burner and vermiculite tray in given order, which is appointed by letters of alphabet. Logs cannot completely cover the shape of the burner which may cause the main burner not igniting properly. This can lead to incorrect operation of the device, and the device may quickly get dirty with soot which adversely affect the image of the flame.



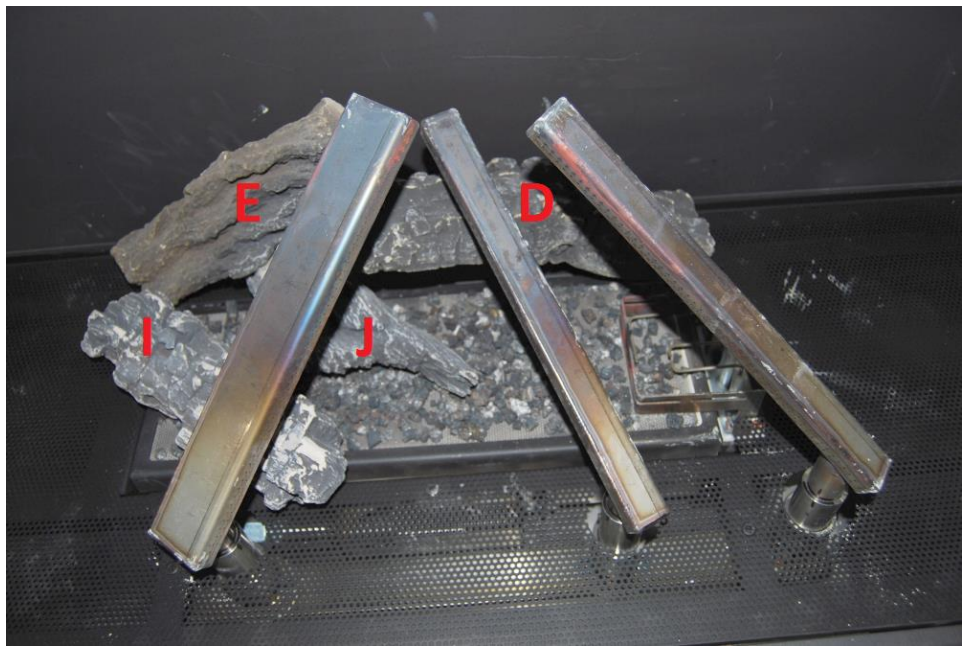
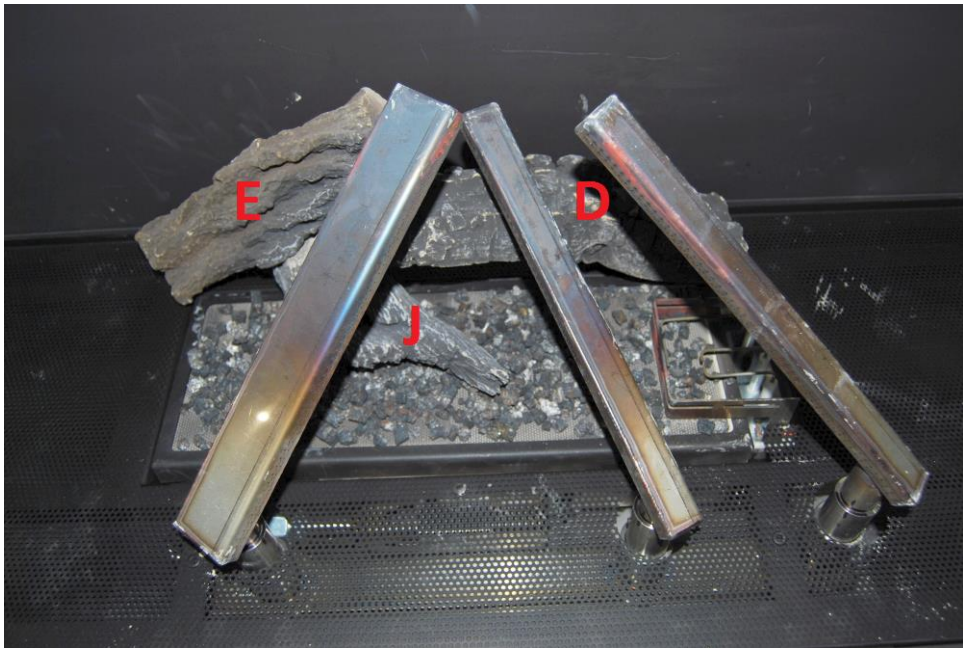



Photo 7 – Placing decorative logs on main burner

- Place the glowing wires on the burner next to or under the decorative logs.

WARNING! The areas around the ionization and ignition electrodes should remain free from glowing wires.

To place decorative logs on the top burners:

- Identify all the ceramic logs from A to C. During the identification, follow the traces of burns on the surface of the branches and their shape.
- Place ceramic logs on the top burners in the order shown below, taking care not to damage the logs.

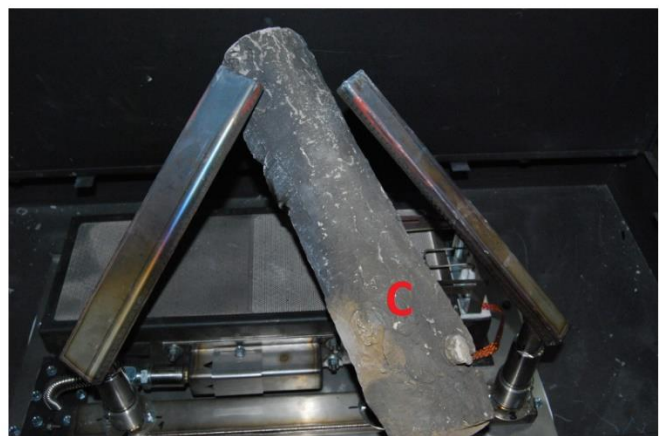

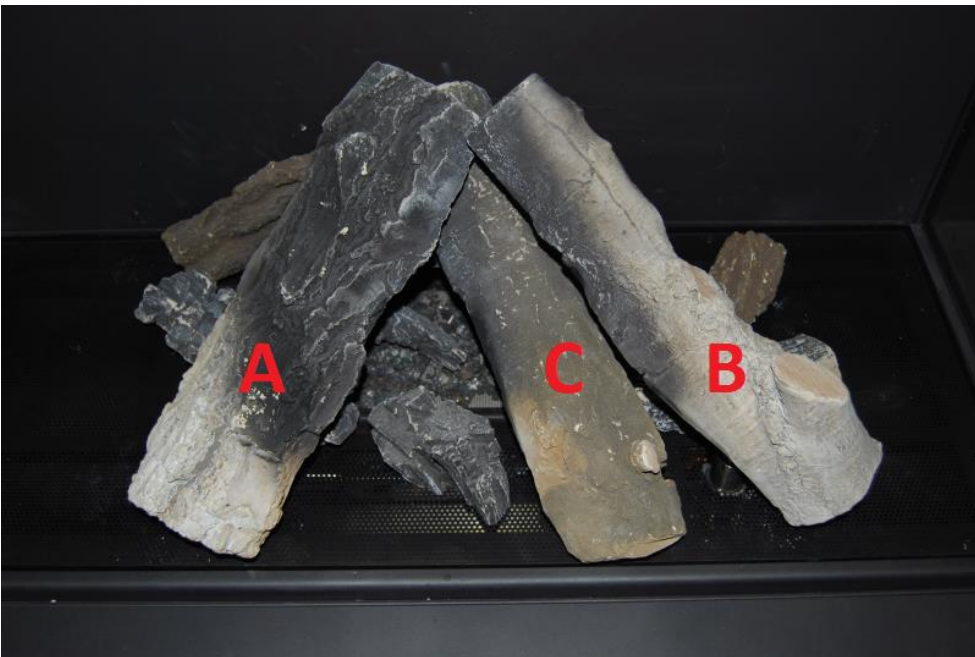

Photo 8 – Placing decorative logs on top burner

5.12. Glasses

Please note that only after proper placement of logs or decorative stones, you can start installing the glass. You should be careful not to damage the glass during handling or assembly.

5.12.1. Assembly of the glass panel

The device is equipped with heat-resistant ceramic glass to withstand temperatures up to 800 ° C. Depending on the glazing of the unit, disassembly and assembly of the front glass takes place in a different way.

WARNING! Avoid leaving fingerprints, because they will burn out on the glass.

To mount the front glass of the device with the front glazing you must:

- Make sure the glass is clean, free from persistent dirt and fingerprints.
- Carefully mount the suction cup in the middle of the glass.
- Holding the glass at angle, insert its upper edge between the body of the fireplace and the horizontal fixing strip (1).
- Slide the glass upwards so that its lower edge is above the lower decorative frame "D" (2)
- Push lower edge of the glass in the direction of the body of the fireplace so that the surface of the glass is in vertical position (3).
- Move the glass down and carefully set its bottom edge inside the horizontal handle.
- Even out horizontally position of the front glass relative to the side walls so that the side edges of the front glass comport with the vertical edges of the side walls.
- Move the horizontal strip fixing front glass "C" (4) to the right until it stops and tighten it with screws "B" (5).
- Make sure that the screws are not tightened too much, because it can then lead to their breakage or damage of the thread.
- Mount the side pressure strips "A" in the holes in the side frame and by pushing them down, lock in the vertical position (6).
- Remove the suction cup.

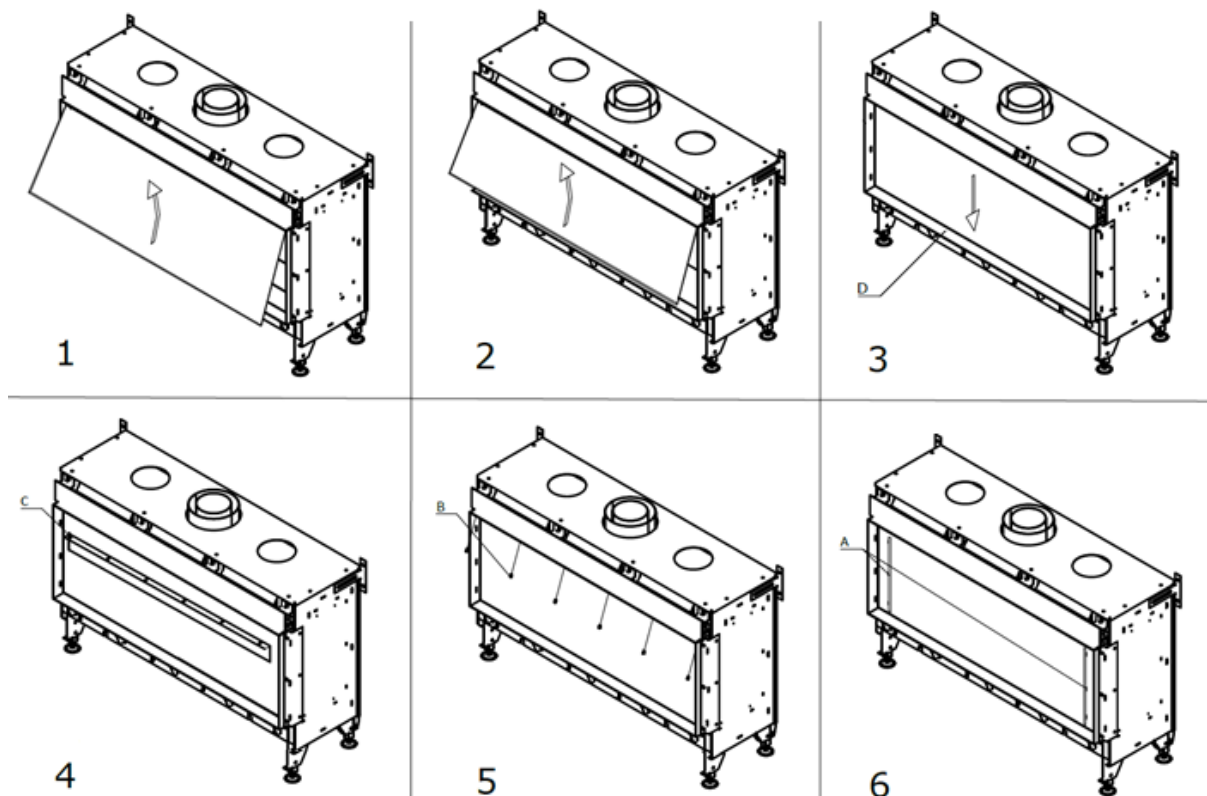

Picture 25 – Mounting of the front glass in the fireplace with front glazing

To mount the front glass in the devices with two glasses, you must:

- Make sure the glass pane is clean, free from persistent dirt and fingerprints.
- Carefully mount the suction cup in the middle of the glass.
- Holding the glass at angle, insert its upper edge between the body of the fireplace and the horizontal fixing strip (1).
- Slide the glass upwards so that its lower edge is above the decorative frame "B" (2).
- Push lower edge of the glass in the direction of the body of the fireplace so that the surface of the glass is in vertical position.
- Holding the glass at all times above the decorative frame „B”, move the glass carefully to the left until it stops (or to the right depending on the glazing version) (3).
- Move the glass down and carefully set its bottom edge inside the horizontal handle (4).
- Even out horizontally position of the front glass relative to the side walls so that the side edges of the front glass comport with the vertical edges of the side walls.
- Move the horizontal strip fixing the front glass to the right until it stops and tighten it with screws "A" (5).
- Make sure that the screws are not tightened too much, because it can then lead to their breakage or damage of the thread.
- Remove the suction cup.

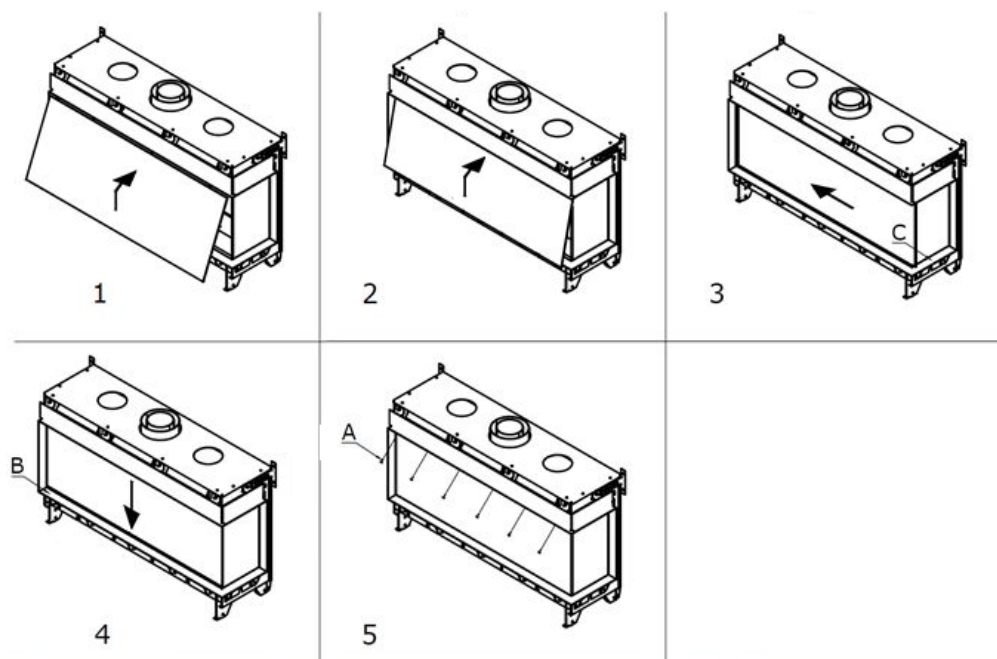

Picture 26 - Mounting of the front glass in the fireplace with two glasses

To mount the front glass in the devices with three glasses, you must:

- Make sure the glass is clean, free from persistent dirt and fingerprints.
- Carefully mount the suction cup in the middle of the glass.
- Holding the glass at angle, insert its upper edge between the body of the fireplace and the horizontal fixing strip (1).
- Slide the glass upwards so that its lower edge is placed above the lower decorative frame "B" (2).
- Push lower edge of the glass in the direction of the body of the fireplace so that the surface of the glass is in vertical position.
- Move the glass down and carefully set its bottom edge inside the horizontal handle (3).
- Even out horizontally position of the front glass relative to the side walls so that the side edges of the front glass comport with the vertical edges of the side walls.
- Move the horizontal strip fixing the front glass to the right until it stops and tighten it with screws "A" (4).
- Make sure that the screws are not tightened too much, because it can then lead to their breakage or damage of the thread.
- Remove the suction cup.

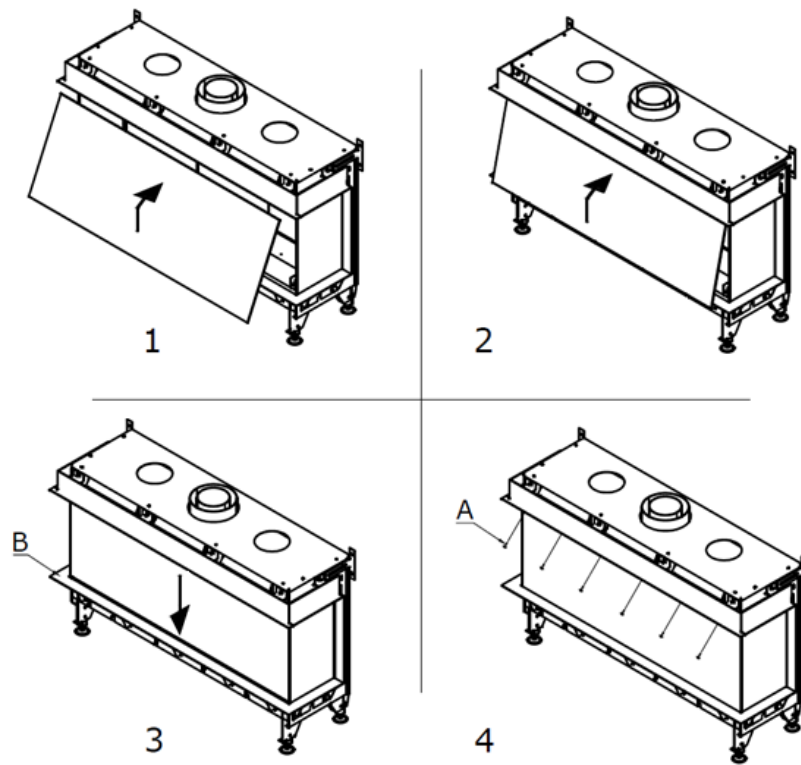

Picture 27 – Mounting of the front glass in the fireplace with three glasses

5.12.2. Dissassembly of the glass

To disassembly the front glass of the device, you should follow the above procedure in reverse order, appropriate for the version of glazing.

If the device is a version equipped with side ceramic glass panels, they are not subject to removal during normal use or during the installation of the device.

To remove the front glass of the device with the front glazing should:

- Make sure the device is turned off, and the glasses are cooled down to room temperature.
- Carefully mount the suction cup in the middle of the glass.
- Remove the side pressure stripes „A” by lifting them up and moving them towards the center of the front glass (1).
- Unscrew the screws "B" pressing a horizontal strip "C" by holding the front glass (2).
- Move the pressure strip to the left and then move down to dismantle it (3).
- Lift the front glass vertically to the top so that its bottom edge is above the decorative frame "D" (4).
- Drag the lower part of the front glass to each other so that its lower edge is beyond the contour of the housing and decorative frame of the device (5).
- Then by making a move down and then towards yourself, you should pull out the front glass and put it in a safe place on a flat surface (6).
- Remove the suction cup.

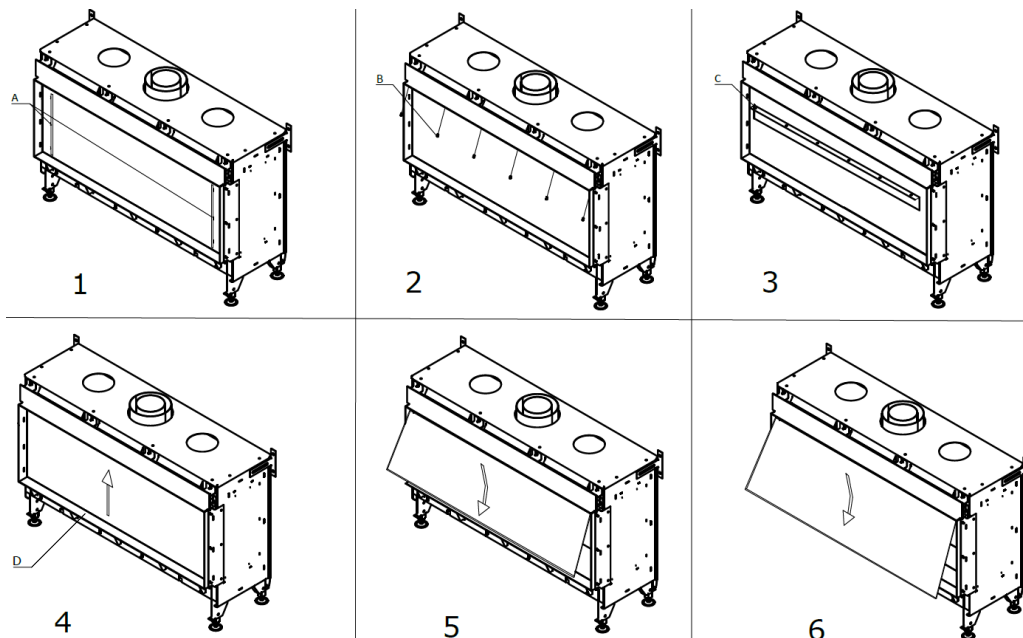

Picture 28 – Disassembly of the front glass in a fireplace with front glazing

To remove the front glass of the device with two glasses, you should:

- Make sure the device is turned off, and the glasses are cooled down to room temperature.
- Carefully mount the suction cup in the middle of the glass.
- Unscrew the screws "A" pressing a horizontal strip, holding the front glass (1).
- Move the pressure strip to the left and then move down to dismantle it.
- Lift the front glass pane vertically to the top so that its bottom edge is above the decorative frame "B" (2).
- Holding the glass at all times above the decorative frame "B" move carefully the glass, making sure that its right edge does not hit the decorative frame "C" (3).
- Drag the lower part of the front glass to each other so that its lower edge is beyond the contour of the housing and decorative frame of the device (4).
- Then by making a move down and then towards yourself, you should pull out the front glass and put it in a safe place on a flat surface (5).
- Remove the suction cup.

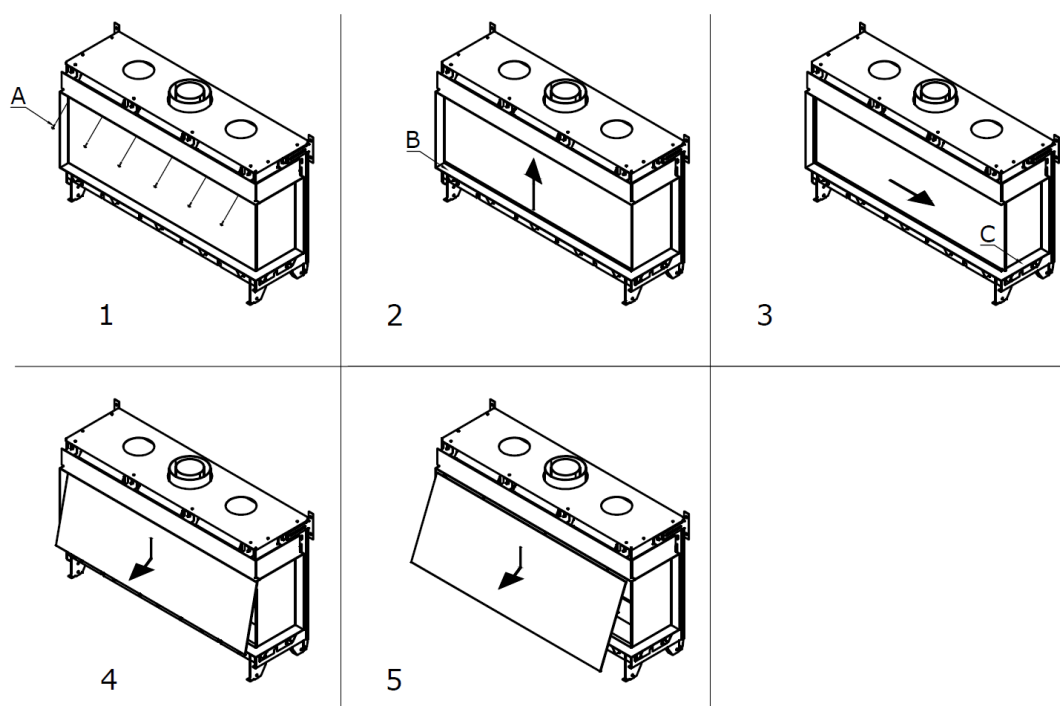

Picture 29 – Disassembly of the front glass in the fireplace with two glasses

To remove the front glass of the device with three glasses, you should:

- Make sure the device is turned off, and the glasses are cooled down to room temperature.
- Carefully mount the suction cup in the middle of the glass.
- Unscrew the screws "A" pressing a horizontal strip, holding the front glass (1).
- Move the pressure strip to the left and then move down to dismantle it.
- Lift the front glass vertically to the top so that its bottom edge is above the decorative frame "B" (2).
- Drag the lower part of the front glass to each other so that its lower edge is beyond the contour of the housing and decorative frame of the device (3).
- Then by making a move down and then towards yourself, you should pull out the front glass and put it in a safe place on a flat surface (4).
- Remove the suction cup.

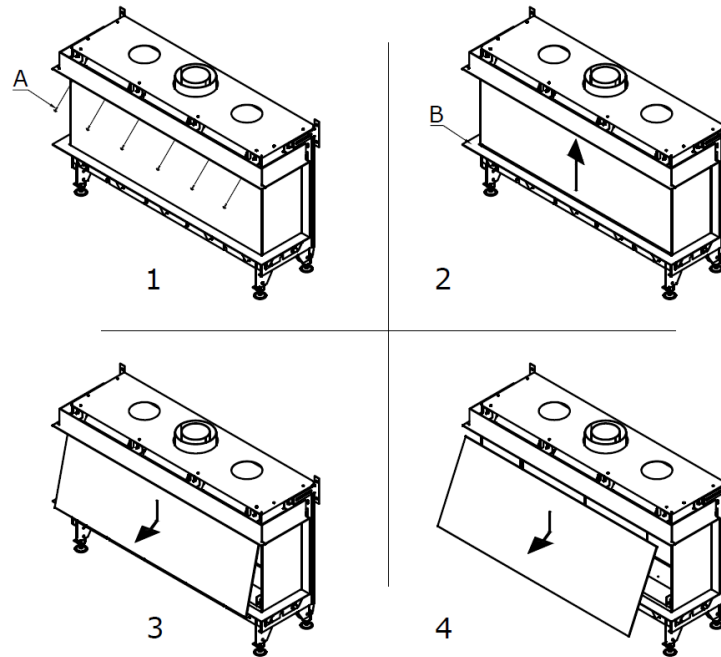

Picture 30 – Disassembly of the front glass in a fireplace with three glasses

6. CONTROL

The unit is supplied with remote control for the user which controls the receiver and allows you to turn on and off the fireplace, and to adjust the height of the flame. Control method using the remote control as well as a description of the device is described in the User Manual. Optionally, orange remote control for the installer can also be supplied.

The remote control receiver is installed in the inspection hatch next to the gas assembly. Exposure of the system's electronic to temperatures exceeding 60 ° C will result in irreversible damage. The maximum distance between the inspection hatch and the device is determined by the length of flexible gas hoses and wires connecting the controller with the electrodes of the hearth. Do not extend the cables supplied with the unit, as this may affect the malfunction of the control system. Keep in mind not to put the ignition wire too close to metal parts. Elements of the system cannot be exposed to moisture, dust, and the factors affecting the formation of corrosion. If you need to replace the individual system components, use only original parts available for purchase from the Manufacturer. Plugs of the individual wires are chosen in such way, as to prevent incorrect connection components.

6.1. Remote controls

6.1.1. Remote control for the user.

To prepare remote control to use, follow these steps:

- Place the two batteries (AA) attached to the device inside the remote control.
- Make sure that the device is not turned off for more than 5 minutes.
- When you first start the device (or if the power supply was switched off for more than 5 minutes), you must configure the connection of the remote control with the device.
- If the remote control is not in the mode of establishing the connection to "BND", follow these steps:
 - Press the menu button (the button with a square symbol) on the remote control for at least 10 seconds and then press it several times until "BND" inscription with symbol of reception appears on the screen.
 - Press briefly and simultaneously buttons "arrow up" and "down arrow" so the blinking warning triangle and hourglass also appear on the screen.
 - Startup screen display means the end of the login process and configured remote control which is now ready to work with a fireplace.

WARNING! All functions are explained in detail with supplied in chapter 9

6.1.2. Orange remote control for the installer

When using optionally supplied orange remote control, you can read all the information stored in the receiver. In this way, you can recover last 20 error messages, and also it is possible to read the number of error occurrences. This remote control is also used to adjust the basic settings and to read off the ionization current flow. It is also required for configuration of wired home automation system connection.

6.2. Alternative ways of control

Except using the remote control, there are also alternative ways to control the device. The fireplace is suitable for connection to a home automation system that can connect to the receiver. This may be a wired.

Planika fireplaces can be (after purchasing an additional Ethernet Bridge module) controlled by Planika Control application available for free download for mobile devices with Android (Google Play) and iOS (iTunes). The installation instructions are supplied with the Ethernet Bridge module. Instructions for use of the Application are included in the Application itself in the Help menu.



6.2.1. Wired connection

Wired connection of the home automation system with the receiver can be set up by using DC 0-3 VDC input (Picture 2 "D").

WARNING! Voltage above 3V causes damage to the receiver and therefore it is not allowed.

In case of home automation systems with output voltage of 0-10 V voltage should be reduced to the level of 0-3 V DC. To do this, use a voltage switchgear made of resistors (e.g., 2200 ohms and 680 ohms). Voltage above resistance of 680 ohms may be used at the output 0-3 V DC. Use a low impedance resistors.

By controlling the voltage level the receiver will be able to calculate the position and height of the flame. Table "B1" shows the relationship between the voltage and the height of the flame. For devices with 2 burners, table "B2" applies. It shows the relationship between voltage, the height of the flame and the number of burners.

B1			
B	V		
1	0,00 VDC	0%	I
1	0,08 VDC	3%	I
1	0,16 VDC	6%	I
1	0,23 VDC	9%	I
1	0,30 VDC	13%	I
1	0,37 VDC	16%	I
1	0,43 VDC	19%	I
1	0,49 VDC	22%	I
1	0,55 VDC	25%	I
1	0,61 VDC	28%	I
1	0,66 VDC	31%	I
1	0,71 VDC	34%	I
1	0,76 VDC	38%	I
1	0,81 VDC	41%	I
1	0,86 VDC	44%	I
1	0,90 VDC	47%	I
1	0,94 VDC	50%	I
1	0,98 VDC	53%	I
1	1,02 VDC	56%	I
1	1,06 VDC	59%	I
1	1,10 VDC	63%	I
1	1,14 VDC	66%	I
1	1,17 VDC	69%	I
1	1,20 VDC	72%	I
1	1,24 VDC	75%	I
1	1,27 VDC	78%	I
1	1,30 VDC	81%	I
1	1,33 VDC	84%	I
1	1,36 VDC	88%	I
1	1,39 VDC	91%	I
1	1,41 VDC	94%	I
1	1,44 VDC	97%	I
1	1,47 VDC	100%	I
	1,98 VDC	Off >	O
	2,00 VDC		O



B2			
B	V		
1	0,00 VDC	0%	I
1	0,08 VDC	6%	I
1	0,16 VDC	13%	I
1	0,23 VDC	19%	I
1	0,30 VDC	25%	I
1	0,37 VDC	31%	I
1	0,43 VDC	38%	I
1	0,49 VDC	44%	I
1	0,55 VDC	50%	I
1	0,61 VDC	56%	I
1	0,66 VDC	63%	I
1	0,71 VDC	69%	I
1	0,76 VDC	75%	I
1	0,81 VDC	81%	I
1	0,86 VDC	88%	I
1	0,90 VDC	94%	I
1	0,94 VDC	100%	I
2	0,98 VDC	6%	I
2	1,02 VDC	13%	I
2	1,06 VDC	19%	I
2	1,10 VDC	25%	I
2	1,14 VDC	31%	I
2	1,17 VDC	38%	I
2	1,20 VDC	44%	I
2	1,24 VDC	50%	I
2	1,27 VDC	56%	I
2	1,30 VDC	63%	I
2	1,33 VDC	69%	I
2	1,36 VDC	75%	I
2	1,39 VDC	81%	I
2	1,41 VDC	88%	I
2	1,44 VDC	94%	I
2	1,47 VDC	100%	I
	1,98 VDC	Off >	O
	2,00 VDC		O

Table 4 – Wired connection voltage

When connecting home automation system to the receiver, proceed as follows:

- Connect the signal 0-3 V DC to the connector, which the black and yellow wire is connected to (Picture 2 "D").

Warning! The yellow wire is "+" and the black is "-". Always connect "-" to "-" and "+" to "+".

- Use the orange remote control to select wired connection. To do this, go to the position 8 in the first menu and select the device with one burner (option 2) or a device with two burners (option 3). In order to familiarize yourself with additional configuration options, please read the instructions that came with the optional orange remote control. By default, the device is configured to use 2 burners (middle and side sections).

7. FINAL INSPECTION

To check whether the device is working properly and safely, before it is put into operation, perform the following checks.

7.1. Gas tightness

All connections must be tight. Check the connections for gas tightness. The gas control block can be subjected to a maximum pressure of 50 mbar.

7.2. Gas Pressure

Burner's pressure shown on the nameplate of the device, is set at the factory and under no circumstances can be changed.

WARNING! You should check the pressure in the home installations, because it may be incorrect. In addition, check the pressure in the gas block system. The location of the measuring nipple (P_{in}) over the gas assembly shows the picture below. If the pressure is not correct (too high or too low), please contact the gas supplier. Also, check the output pressure of the gas by connecting the measuring device to the measuring nipple and compare them with output pressure of the burner written on the nameplate of the device. To connect the measuring device, unscrew the screw on the test nipple (9 mm) by half a turn and connect the hose.

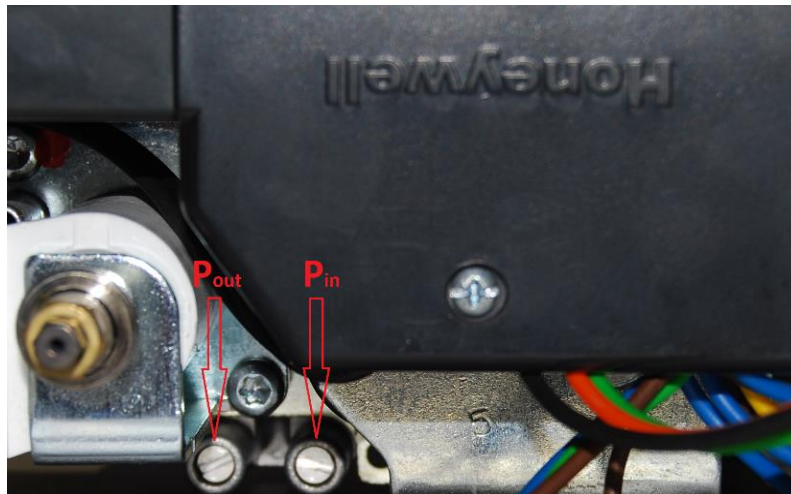

Photo 9 - Nozzles measuring gas pressure

7.3. Ignition of the main burner

Information about the ignition of the main burner can be found in the Manual.

7.3.1. First ignition of the device after installation or after modifications

WARNING! After installation of the device or after service work you should light up the device for the first time without inserting the front glass. If necessary, drain the gas pipe.

Follow the procedure below:

- If necessary, remove the glass.
- You should start the ignition as described in the Manual..
- If the main burner does not light up:
 - Reset the system by pressing the remote control buttons simultaneously "arrow up" and "down arrow".
 - Repeat the ignition until the main burner lights up.

WARNING! After each failed attempt ignition system must be reset.

- If after several attempts the burner still does not light, refer to the table of error messages (see. Chapter Troubleshooting).
- In the first place middle section of the device will be lit for 100% of its power, and when it detects the ionization, device goes on 50% of its power. The detection must take place within 10 seconds. Otherwise, the device goes into failure mode. After about one minute from the start of the middle section, the second valve supplying gas to the side section of the hearth turns on, and the unit returns to its full capacity. You can hear then the characteristic "click".
- Make sure that the hearth is burning all the time.
- If the hearth is not burning all the time, reset the system as described and repeat the ignition procedure until the furnace will burn continuously.

WARNING! The system can be reset to re-ignition only three times in a row. Then the system will be permanently blocked and you have to wait half an hour before another ignition attempt.

- Please refer to the table of error messages, if this does not happen after a few attempts.
- Disconnect the device from the power supply.
- Then mount the glass as described in section 5.12.1.
- Repeat the ignition procedure several times and perform the checks described in section 7.3.2.
- Since then, the hearth should light up without problems.

WARNING! Always wait 3 minutes before retrying ignition of the device. You cannot make any modifications to the gas assembly.

7.3.2. The Hearth

- Ignition electrode should light the central hearth within few seconds and without explosively.
- Flame in the middle hearth must smoothly and without the explosively pass through the burner and must burn continuously.
- The side sections of the hearth should fire off immediately after the activation of the second valve, and the transfer of the flame on the side sections must be smooth and without explosively.
- If there is no ignition of the device after three restarts, the permanent lock the device is activated and it may be impossible to reset by disconnecting the power supply. If you still need to restart, remove the glass and make sure that nothing is blocking the free flow of gas to the burner. Then, the device can be disconnected from the power source for 10 seconds. After these 10 seconds the power supply can be reconnected. It should light up the device in the same way as in the case of the first ignition, according to the information contained in Section 7.3.1.
- Check the operation of the burner from a cold state.
- If the sparks are detected between the electrodes, the central hearth should ignite within a few seconds.
- The image of the flame and the correct transfer of the flame to the side sections of the burner can be evaluated properly only when the front glass is mounted.
- If the ignition of the main burner does not correspond to the above requirements, refer to the table of error messages to determine the cause.

7.4. Flame

WARNING!!! The image of the flame depends on the type of gas used. Different types of propane and butane gas mixtures, as well as various types of natural gas, can cause a change of the color and appearance of the flame, smoke or even soot effect on the decorative elements (ceramic logs and pebbles). Improper flue draft will also change the image of the flame by extending or decreasing the flame size. Place decorative elements according to chapter 5.11 and avoid putting logs directly above the flame which will cause blue shade of the flame.

An image of the flame can be effectively evaluated after the first few hours of use. The image of the flame is affected by the volatile components of paint, materials, etc., which evaporate during the first hours of the fireplace use.

- Make sure that the image of the flame on the hearth is correct.
- If the image of the flame is not acceptable, use the table of error messages to solve the problem.

7.5. Checklist

	Range	Actions
1	General inspection	<ul style="list-style-type: none"> • Carry out the procedure in firing up the fireplace • Check the operation of all safety systems. • Check if the flame of the main burner burns steadily • Check if the main burner is burning evenly • Check the correct operation of all modes of the remote control.
2	Glass Control	<ul style="list-style-type: none"> • Make sure that the glass has no cracks. • Make sure the glass fits tight to the body of the fireplace. • Check the wear of the seals. If necessary, replace the seal. • Check the degree of contamination of the glass. Clean the glass if necessary.
3	Inspection hatch control	<ul style="list-style-type: none"> • Check the tightness of the gas connections • Check if the inspection hatch has adequate ventilation • Check whether the connection between the controller and the receiver is not damaged. • Check whether the gas control system components are not exposed to high temperatures • Check if the inspection hatch is not exposed to moisture. • Check if the connecting cables show no signs of corrosion.
4	Combustion chamber control	<ul style="list-style-type: none"> • Check whether the ignition electrode is not obstructed by decorative elements • Check if the ionization electrode is within the range of the main burner flame • Check whether the combustion chamber does not require cleaning. • Check if the spaces supplying air from the flue pipe system to the combustion chamber are not obstructed. If necessary unblock those spaces. • Check whether the combustion chamber has no signs of corrosion. If necessary, remove corrosion and cover the losses with a new coat of fireplace paint. • Check if the main burner ignites smoothly.
5	Flue Control	<ul style="list-style-type: none"> • Check the tightness of the concentric flue system • Check the patency of the concentric flue system.
6	Monitor of the control devices	<ul style="list-style-type: none"> • Make sure the receiver is not damaged. • Check if the circuits has no breakthrough • Make sure the power supply cable is not damaged • Check that the components of the control system are not exposed to overheating.
7	Housing control	<ul style="list-style-type: none"> • Make sure the casing of the gas insert has no cracks • Check whether the combustible elements are at a safe distance from the casing of the fireplace.
8	Decorative elements	<ul style="list-style-type: none"> • Check that the decorative elements do not require cleaning • Check that the decorative elements are not in contact with the glass • Check if the decorative elements are not damaged.

Table 5 – Checklist

8. USAGE

Before first use of the fireplace, make sure that all connections of individual elements of the system have been made according to the instructions. Incorrect connection of system components for gas or faulty connection combustion system may cause an improper operation of the device or damage it.

8.1. First use

The first time you turn on the fireplace Monroe, it is necessary to use it at the maximum level of the flame for few hours so that the elements warm themselves, and possible small residues of paints, coatings and lubricants will evaporate. During this period, additional ventilation and ventilation of the room where the appliance is installed is recommended, because the characteristic smell of evaporating powder paint may be felt for about another hour of use. It can be particularly sensitive to volatile vapors may be pets (mainly birds).

If during your first startup of the device, sediment will appear on the inner surface of the glass (glasses), turn off the device and allow it to cool to room temperature, and then clean the glass (see section 15.2). The formation of the RAID is caused by burning volatile components of paints, which initially may also have an impact on the image of the flame.

Fireplace installed in the housing should be fired for the first time after complete drying of all the walls of housing. This prevents the formation of cracks due to shrinkage of the materials. If the walls of the fireplace housing are made of stone materials, leave it to dry for at least 6 weeks prior putting the unit into operation.

8.2. Discoloration of walls and ceilings

When using gas heating, you can meet with a phenomenon of electrolytic colouring of walls and ceilings. It is caused by the movement of air convection, and dust particles contained therein. Brown discoloration may also occur during combustion of substances as a result of inadequate ventilation, smoking, the use of candles and oil lamps. These problems can be partially prevented by ensuring adequate ventilation the room in which the device is located.

9. REMOTE CONTROL

The device is equipped with a wireless radio remote control (868MHz) enabling manual change of the flame height. It also has a built-in temperature sensor, which can be read on the LCD display.

9.1. Display and buttons

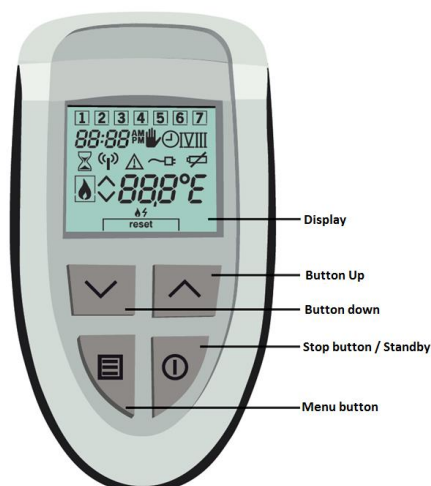

Picture 31: Remote Control

9.2. Explanation of symbols

	Manual Control
	Active timetable
	Active period
	Closed fireplace (on the left) and open (on the right)
	Decorative flame on
	Decorative flame can be ignited.
	Decorative flame error, you can reset
	Burner off/setting down (on the left)
	Burner on/setting up (on the right)
	Operation in progress (e.g. when decorative flame is turning on)
	Failure
	Radio communication
	Batteries low (flashing symbol)
	Display format of discharge 12-hour or 24-hour
	Days of the week. Square indicates current day
	Temperature display
	Temperature sensors error

Buttons:	
	Increase settings or change the selection
	Decrease settings or change the selection
	Choose the menu and choice of the menu
	Stop the set up menu or go to standby mode

Table 6: Remote control symbols

9.3. Setting connection between the remote control and the receiver

After replacing the batteries or during your first installation, you must establish the communication code between the remote control and the receiver to be able to use the wireless remote control. The receiver is in the mounting bracket together with the gas valve and electronic control unit.

The remote control can communicate with a device only when it is registered on the device. To do this, you must do the following:

- Press and hold the button on the remote control for 10 seconds.
- Then press for a short time the same button several times until screen „1” appears.



- Briefly press buttons and at the same time until screen 2 appears. After a successful completion of the process of setting up the communication, startup screen will be displayed.

If the connection fails, screen 1 will appear again.

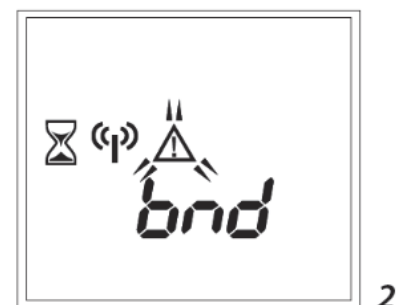

Setting a new communication code is required after each battery replacement or after a power failure for more than 5 minutes.

WARNING! It cannot be ruled out, although it is unlikely that the ignition of the device can be started unintentionally by other remote controls (for example, remote control of another gas heater, car remote control or remote control for garage doors working in the 868 MHz band). As a result, the device can be ignited at the wrong time, also during our absence. In the event of such situation, you must take the following preventive measures:

- establish a new communication code between the remote control and the receiver (if accidental ignition took place).
- Close the gas valve near the device, if the device will not be used for an extended period of time. This is the safest remedy.
- Change the position of the receiver to minimize the possibility of receiving unwanted radio signals.
- Follow the specific instructions of the security measures, even if the device is not in use.

9.3.1. Battery exchange

Before using the remote control you must place the two supplied batteries (type AA). After inserting the batteries and after connection to receiver, the remote control is ready to operate the fireplace by manual adjustment of the flame height. To extend battery life, after some time the button was last pressed, the screen goes blank, unless the device is turned on.

If the display shows the flashing symbol , replace the batteries. If the batteries are completely discharged, the display goes off. Therefore, you should replace the batteries in the remote control. To change it, you should:

- Remove the back cover of the remote control by moving it a few millimeters down (Picture 32, Part 1) and lifting it to the top.
- Remove the old batteries from the housing.
- Place the new battery pack in the housing (Picture 32, Part 2).
- Mount the back cover of the remote control, placing the tabs A and B of the rear cover (Picture 32, Part 3) in the corresponding notches of the remote control housing (Picture 32, Part 2).
- Push the rear cover upwards to lock it.
- After replacing the batteries, re-establish communication code, the current time and day of the week (it is necessary if you use the time schedule).

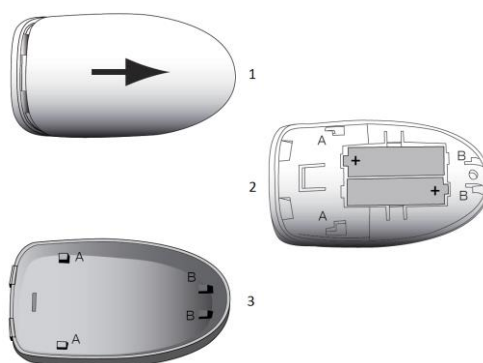

Picture 32: Battery exchange in the remote control



WARNING! Do not throw exhausted batteries together with other household waste, but dispose of them as chemical waste.

10.USER MENU

The user menu is composed by default with five screens that allow you to access the following features:

- Screen 1: Eco Flow
- Screen 2: Relay (additional electric receiver such as lighting)
- Screen 3: Fan / Damper
- Screen 4: Choice of control options
- Screen 5: Time menu



If the user do not plan to use all the options and related features available in the user Menu, the user can disable it through the appropriate configuration in the installation Menu. These features will no longer be visible in the user Menu on the remote control.

To activate the user Menu, you should press and hold button  for 2 seconds. You can go out of User Menu by pressing  button or after waiting five seconds of pressing the last button.

10.1. Eco Flow

Eco Flow, allows you to change the height of the flame automatically, within a programmed range, without user interaction, and without need to manually change the height of the flame. This enables you to save energy and reduce gas consumption with satisfaction of preserving the beautiful appearance of the flame Using the remote control, this feature can be enabled and disabled. Please note, however, that this is only possible when the device is turned on. By default, the Eco Flow is turned off.

To activate or deactivate the feature Eco Flow, you should:

- Go to the Screen 1 of the user menu, by pressing and holding the button  for 2 seconds.
- Activate or deactivate the Eco Flow by pressing the arrow keys on the remote control  or  („1” means activating and „0” means deactivating of Eco Flow).

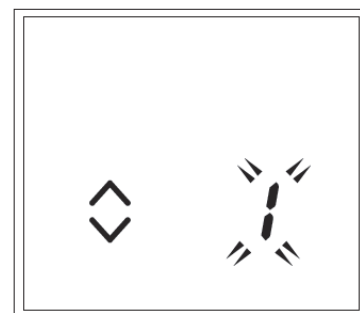





Screen 1.

10.2. Relay - control of additional optional lighting

Gas valve control electronics gives you the ability to connect an optional lighting (for example, to highlight the Interior of the housing) or any other electric receiver and allows you to control it with the remote control. Built-in relay can be used to control the AC Receiver (max 230V AC\0, 5A).

This feature can only be turned on and off by using the remote control. To activate or deactivate receiver connected to electric relay, you must:

- Go to Screen 2. Of the user menu, by pressing and holding button  for 2 seconds. Then, again press the button .
- Enable or disable electric receiver function by pressing the arrow buttons on the remote control  or  („1” means activating and „0” means deactivating).







Screen 2.

10.3. Fan or damper control

Electronics controlling gas valve gives you the ability to connect and control via optional fan or throttle powered with AC (max 230V AC/0, 8A), mounted for example in the wall of the fireplace housing. The fan can be used to improve air circulation within the housing or to distribute warm air from inside the housing to the other rooms.

Using the remote control this function can only be switched on and off. To enable or disable connected fan you should:

- Go to Screen 3. Of the User Menu, by pressing and holding the button  for 2 seconds. Then briefly press twice the button .
- Enable or disable fan by pressing the arrow buttons on the remote control  or  („1” means activating and „0” deactivating).

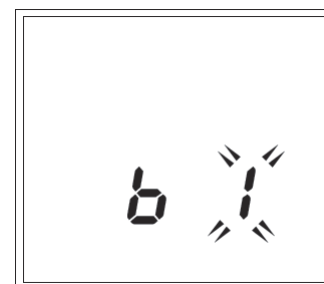



Screen 3.







10.4. The choice of control options

The remote control is configured by default to manual control mode. To use the time schedule, select the appropriate option in the installation Menu (Chapter 11). After proper configuration in the installation Menu, features of the time schedule will be available and you will be able to find them on the screen 4 (and subsequent) in the user Menu.

WARNING!!! When using the Application for mobile devices, the Temperature Control mode with Time Schedules is not available. There are also invisible all screens on the Remote Control Menu related to the configuration and setting of time schedules.



To make the choice of how to control a fireplace:

- Go to Screen 4 of the User Menu, by pressing and holding the button  for 2 seconds. Then briefly press three times the button .
- There are three possible control modes of Fireplace control, symbolized by two flashing symbols:

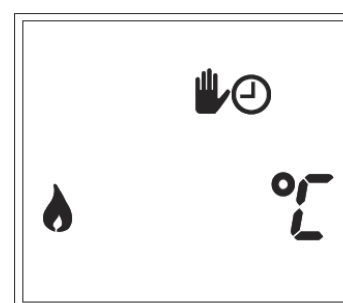
-  +  ○ Manual control with adjustable flame height
-  +  ○ Manual control with the temperature control,
-  +  ○ Time schedule (temperature control).



Screen 4.







- the desired way to control a fireplace you should select by pressing the arrow buttons  or  on the remote control.
- Leave the Menu by pressing a button  or after waiting five seconds of pressing last button.

10.5. Date and time settings

In the Time Menu (Screen 5 User Manual) the following settings are available:

- Time,
- Day of the week,
- Time schedule.

To change the current settings, you should:

- Go to Screen 5 in the User Menu, by pressing and holding the button  for 2 seconds. Then briefly press three times the button . The currently set time starts flashing.
- Using the arrow keys  or  set the correct time on the remote control.
- Press again the button . Days of the week will flash.
- Using the arrow keys  or  set the correct day of the week. Open square indicates the selected day.

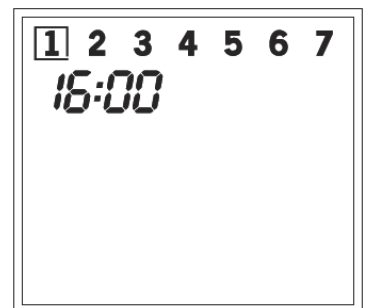

WARNING! Weekdays are not visible if you choose a one-day time schedule.





10.6. Setting the time schedule

Depending on the choices made in the Installation menu available options may include the following time schedule:





- Time schedule with the same settings for each day
- Time schedule with separate settings for weekdays (Monday to Friday) and the weekend
- Time schedule with separate settings for each day.

For each day, you can set two, four or six different periods. Time schedule can easily set the start time and set temperature point for each period. Setting all time schedules is done in the same way, regardless of the amount selected in the Installation menu.

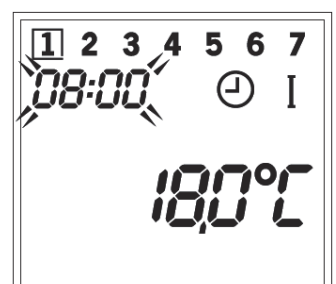
To change settings of the time schedule you should:

- Press and hold the button  for 2 seconds, then again briefly press the button six times . Start time of the first period flashes.
- Using the arrow keys  or  on the remote control set the correct start time of the first period.



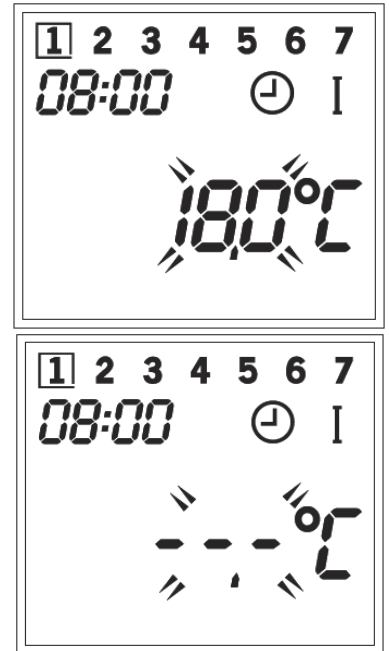

- Press the  button again. Desired temperature of the first period flashes.
- Using the arrow keys  or  set the correct temperature and time on the remote control.
- Press the  button again and repeat the above steps to set the desired start time and the setpoint temperature for all periods and days.
- It is also possible to shut down the device at specific time in the current set period. To do this, select „--,-" when setting the desired temperature.



11. INSTALLATION MENU



The following options are available in the installation menu:

- Time format of 12-hour or 24-hour,
- Time Schedule (1 day, 5 + 2, 7 days),
- The number of periods during each day (II, IV or VI).

To activate the Installation menu you should exit the User Menu (if it is enabled), and then press and hold the button  for 10 seconds. You can leave Installation Menu after pressing the button  or after waiting five seconds of pressing last button.

11.1. Time format of 12-hour or 24-hour



To change the time display format:



- Press and hold the button  for 10 seconds. The currently selected time display format starts flashing.
- Change the format of the time display by pressing the arrow buttons on the remote control  or .



11.2. Time schedule (1day, 5 + 2, 7 days or manual)

To change the time schedule you should:

- Press and hold the button  for 10 seconds, and then briefly press again the  button. Screen with one of the four currently used timetable will appear. Screen with the symbol  means the manual mode and the lack of the currently selected time schedule. In this case, it is only possible to manually control the height of flame.



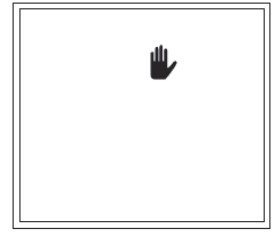
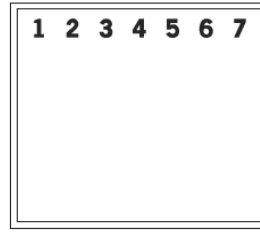
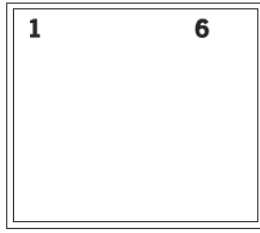
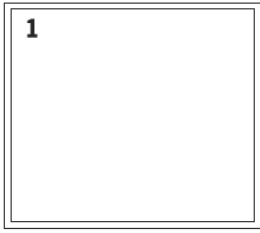

- Select the desired time schedule by pressing the arrow keys on the remote control  or :



- Time schedule with the same settings for each day.
- Time schedule with separate settings for weekdays (Monday to Friday) and the weekend.
- Time schedule with separate settings for each day.
- Manual Mode.

11.3. The periods during the day (II, IV or VI)

To change the number of available periods during the day (II, IV lub VI) you should:

- Press and hold the button  for 10 seconds, and then briefly press again the  button. The currently selected number of periods per day starts flashing.
- Select the desired number of periods per day by pressing the arrow keys on the remote control  or :

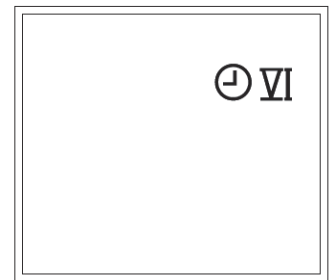
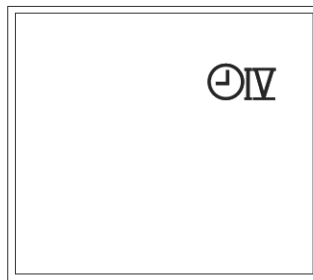
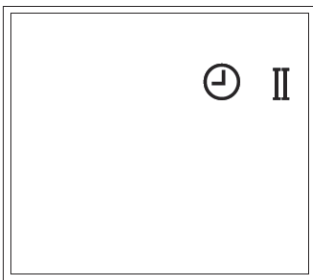



- II – two periods during the day,
- IV – four periods during the day,
- VI – six periods during the day,



11.4. User Menu Settings

It is possible to configure the options in the User Menu, including the deactivation or change the default settings of Eco Flow function, work status of Relay "L" and use of Fan/Damper "B".

To change the default settings for the options that are available in the user Menu you should:

- Press and hold the button  for 10 seconds, and then briefly press again the  button. Current state of function Eco Flow marked with digit will start flashing.





- Select the desired state of the option available in the user Menu by pressing the arrow buttons on the remote control  or :
 - 0 = not available in the menu
 - 1 = by default, always off
 - 2 = by default, always on
 - 3 = last position
- To go to the configuration of the Relay operating mode and the Fan support you must again press the  button.

12.CONTROL

The remote control has a display and four buttons. Thanks to this, operation of the device is simple and settings can be easily changed. There are two settings Menu available:

- User Manual (see chapter 10)
- Installation Manual (see chapter 11)



To activate the User Menu, press and hold the button  for at least 2 seconds. To activate the Installation menu, press and hold the button  pressed for 10 seconds.

12.1. Manual control



After selecting the device manual control in the user Menu, the device switching on and off as well as the temperature control or the height of the flame is carried out manually. Otherwise (if the device is configured in time schedule mode) manual control of the device is not possible, and the process of switching on and off is performed automatically according to the set switch-on time and according to set target temperature in the room.

WARNING! If you select the automatic mode of controlling the fireplace, it is important that the remote control is not in the immediate vicinity of the fireplace and lay freely in easily accessible location. This will allow you to avoid passing incorrect information by the thermometer (integrated in the remote control) to receiver controlling the operation of the fireplace, about the temperature in the room.

12.1.1. Ignition of the device

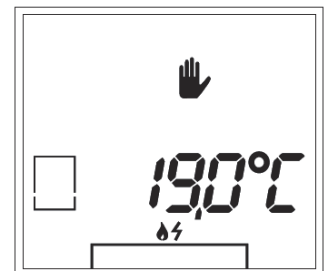

To start the process of firing the device, which is ready for use in manual mode, simultaneously press and hold for at least 2 seconds  and  buttons on the remote control. The gas supply to the furnace will open and you will hear the sound of working ignition electrodes.

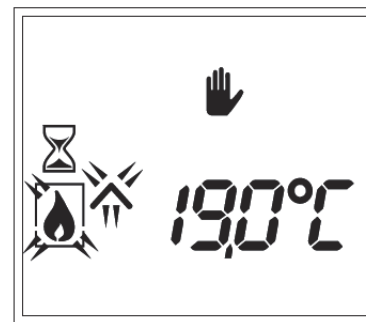

During the ignition on the screen of the remote control, symbols  and  will start flashing, which indicates the fact that, the ignition process of the device is taking place and you will also see the hourglass symbol, which will not let you manipulate the fireplace. In the first place the middle section of the device will be lit on 50% of its power. After about one minute solenoid valve gas supply turns on to the log burners and the device switches to its full performance. The hourglass symbol will disappear which indicates the end of the ignition process.







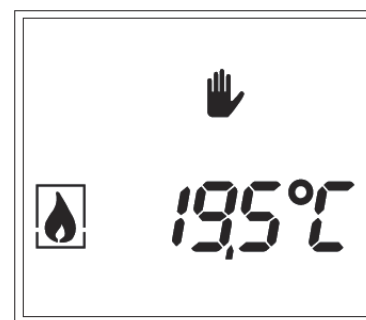

WARNING! If there is no ignition of the device after three restarts and the permanent device lock activates, it may be impossible to reset it by disconnecting the power source. In such cases, contact your dealer or installer.

When the symbol  on the screen will disappear and symbol  will stop flashing, it means that the ignition of the device was completed correctly, and the fireplace is ready to use. From that point on, manual flame height adjustment will be possible.



12.1.2. Flame height adjustment



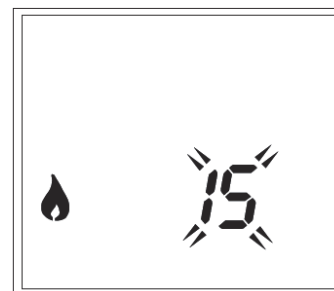



To change the height of the flame, you must press once button  or  on the remote control. You should see on the screen flashing, currently set value of the flame height. Set the required flame height by using the buttons  or . Depending on which button is pressed, the symbol  or  will be briefly visible on the screen. Flame height can be set as a numeric value in the range from 1 (the lowest flame) to



15 (highest flame). By default, the device is started at the highest flame level that can only be adjusted when the machine is turned on. You can go back to the main screen by pressing the button  or wait five seconds after pressing the last key.

12.1.3. Temperature regulation

To control the device through manual adjustment of the desired temperature in the room, proper configuration in the user menu (Section 10.4) will be necessary. The device will then turn on and off automatically depending on the manually set temperature and heat demand. If the room temperature is approaching the temperature set by the user, driver of the device will automatically reduce the height of the flame. If the temperature exceeds the temperature set by the user, the device driver will automatically turn off the fireplace and start it again if the room temperature drops below the temperature set by the user.

To change the desired temperature, press once  or  button on the remote control. The display shows currently set flasing temperature. Set the required temperature by using the buttons  or . Depending on which button is pressed, the symbol  or  will be briefly visible on the screen. Temperature can be set as a value in the range from 5,0 °C to 35,0 °C.

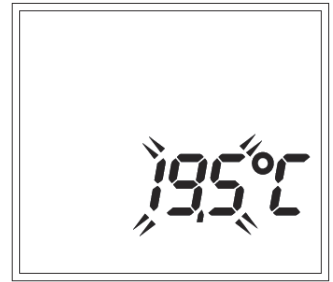



WARNING! The remote control is equipped with a thermostat and must be in the same room as the unit. Place it always in the same place, free from drafts, and do not expose it to direct sunlight and heat radiating from the fireplace.



Back to the main screen can be done by pressing the button  or after waiting five seconds of pressing last button.

12.1.4. Temporary disruption of the temperature control

Although the fireplace in the temperature control mode turns on and off automatically depending on the set temperature, it can also be temporarily disabled by the User.

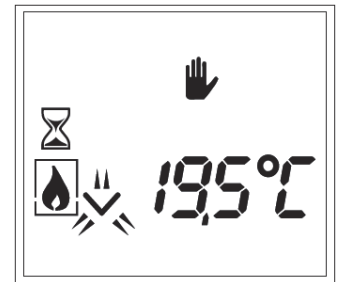
To temporarily turn off the device, press the button . You will see hourglass symbol on the screen and the symbol  will start flashing, which means that device is turning off. Set point temperature cannot be adjusted during a temporary shutting down of the device, operating in temperature control mode.





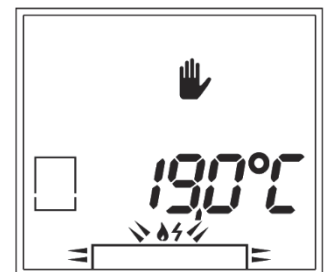

After turning the device off, symbol  will start flashing on the screen, which means that the device can be turned on manually by simultaneously pressing buttons  and . When the device is re-lit, temperature control will be active.





12.1.5. Switching on and off the log burners

The log burners can be turned on or off by using a combination of buttons on the remote control:

- Simultaneous pressing buttons  and , will disable the log burners.
- Simultaneous pressing buttons  and , will enable the log burners. The middle section of the furnace enters the highest flame mode (to ensure proper and immediate firing of the log burners) and after a moment, it returns to a level where it was before turning on the log burners.

Switching on and off the log burners is only possible when the device is in manual mode, which symbolizes the sign  on the screen.

12.1.6. Turning off the device

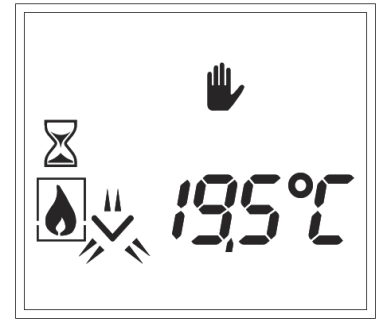

To turn off the device, you should press the  button on the remote control. Hourglass will appear on the screen and the symbol  will start flashing, which means that the turning off the device is in progress. When you turn off the device, the default screen will be displayed again and the hourglass will appear, indicating that for security reasons, rebooting of the device will be possible only after 3 minutes from the moment it was switched off.









12.2. Automatic control - Time Schedule



To control the device using the time schedule, the right configuration in the user menu is needed (Section 10.6). The device will then fully turn on and off automatically depending on the set temperature, the set time of switching on the device in each of the chosen periods and depending on the heat demand.

12.2.1. Temporary change of temperature setpoint

Preset setpoint temperature for a given period within the time schedule can be temporarily increased or decreased by pressing the appropriate buttons  or .

To change the setpoint temperature, press once the button  or  on the remote control. The display shows flashing, currently set temperature. Temporarily set the desired temperature using the buttons  or . Depending on which button is pressed, the symbol  or  will briefly appear on the screen.



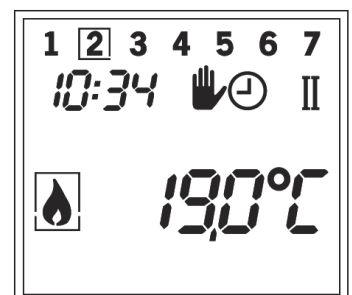

After pressing button  or after waiting five seconds from the time you press the last button, you return to the main screen where in addition the symbol  appears, indicating that the set point temperature was adjusted manually. Temporary temperature change can be canceled, by setting the manually changed value set on the previous value given for the current period. In the case of the transition to a new period, temporary setting is automatically canceled.





12.2.2. Temporary disruption of the time schedule

Although the fireplace in the time schedule mode turns on and off automatically depending on the set temperature, it can also be temporarily disabled by the user.

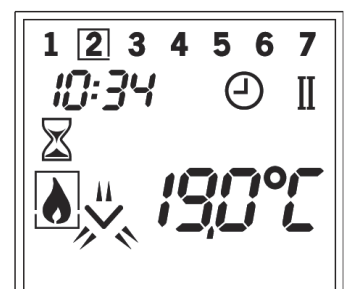

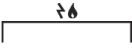
To temporarily turn off the device, press the  button. The display shows the hourglass symbol and the symbol  will start flashing, which indicates that the device is turning off. Set point temperature cannot be adjusted during a temporary disruption of the time schedule.

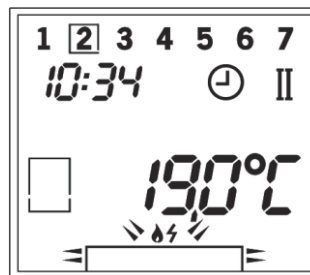

After turning the device off, symbol  will start flashing, which means that the device can be turned on manually by simultaneously pressing buttons  and . When the device is re-lit, time schedule will be active.





13.SIGNAL QUALITY

To check the quality of the signal between the transmitter (remote control) and the receiver located in the mounting bracket together with the gas valve and the control unit, you should press simultaneously buttons  and .

The screen will show the RSSI value (received signal strength indicator), which means:

- from -20 to -80 – good received signal strength,
- from -80 to -100 –Poor received signal strength. In order to improve the signal strength you should place the remote control closer to the unit or change the position of the receiver to minimize the possibility of receiving unwanted radio signals.



In the event of a communication error between the remote and device, this error will be indicated by a failure sign  and the flashing sign of lack of communication  on the remote's screen. Most likely, the distance between the device and the remote control is too large and the remote should be placed closer to receiver. If the error persists despite the change in the distance between the remote and the receiver, you must again carry out the process of establishing communication code.

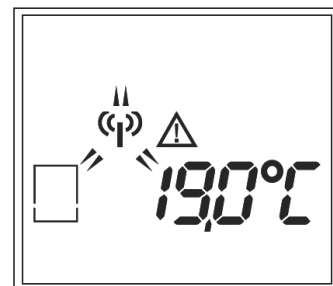



14.TROUBLESHOOTING

WARNING! Installation, repair and maintenance must be performed by trained installer with the appropriate permissions, service company or gas supplier.

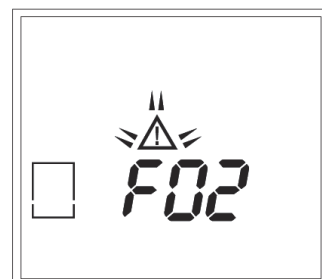
In case of any fault or failure an error code indicating the potential emergency situations will display on the screen of the remote control. The display will show the letter "F", after which you will see a two-digit error code. Full list of error codes is shown in the table below, which presents a summary of any incident that may occur, possible causes and ways to overcome them.



The error code can be reset by simultaneous pressing the buttons  and  on the remote control (when the device is not permanently locked, eg. following repeated ignition attempts). The error code will disappear and it will be possible to restart the device.

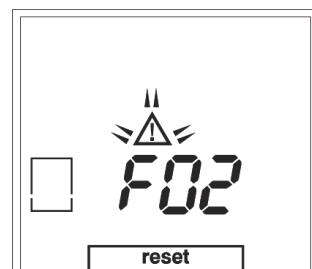

WARNING! You cannot use the device if the fault is repeated. Please contact your installer.

In the case of an error message F01 or F08 you can reset and try to turn the device on up to 3 times in a row. If ignition fails, F00 error appears on the display and ignition is not possible for another 30-minutes.

ERROR CODE	FAULT	POSSIBLE CAUSE	REPAIR
	SMELL OF GAS	IMMEDIATELY CLOSE THE GAS VALVE ON THE GAS CONNECTION. DO NOT USE THE APPLIANCE UNTIL SPILLS ARE FULLY REMOVED	
F00	Flame not detected in time and the burner control doesn't report a failure.	F01, F07 or F08 appeared 3 times	Device blocked. Wait 30 minutes before trying again.
		No spark	Make sure that the distance between the electrodes is 3-4 mm
		No Gas	Make sure, there is a gas connection
F01	The lack of communication between the receiver and the automation controller	Communication cable does not make any contact	Make sure that the contacts of the communication cable ensure correct contact
		Damage to the communication cable	Replace the communication cable
F02	Overheating of the receiver (60 ° c above room temperature)	Poor ventilation by the receiver	Improve ventilation at the receiver
		The receiver is in contact with the hot parts	Move the receiver so that it does not touch the hot parts
F03	Internal NTC sensor(of the receiver) is not working properly	Damaged receiver	Replace Receiver
F04	External NTC sensor is not working properly	External NTC sensor or wiring are damaged	Replace the NTC sensor or wiring
F05	Internal security error	Damaged receiver	Replace Receiver
F06	Lack of communication between the transmitter and receiver	The transmitter is out of range of the receiver	Make sure that the transmitter is located near the receiver
		Any obstacles between the transmitter and the receiver may interfere with the signal	Remove any obstacles between the transmitter and receiver
		Power transmission is too weak	Check the power transmission (see. Instruction Manual Chapter 9)
F07	Flame not detected in time and the burner control doesn't report a failure.	No spark	Make sure that the distance between the electrodes is 3-4 mm
		No Gas	Make sure, there is a gas connection
F08	No ionisation / The burner control reports a failure and the flame could not be detected in time.	No spark	Make sure that the distance between the electrodes is 3-4 mm
			Replace the ignition electrodes
			Check if the cables for the ignition electrode are connected correctly
		No Gas	Make sure, there is a gas connection
		Poor transfer of the flame from the main burner	Check the position of the blocks of wood / debris
			If necessary, remove dust and dirt from the holes of the burner
		Extinguishing of the flame at the ionization electrode (braising or picking of the flame)	Check the tightness of the fireplace combustion chamber, proper adhesion of glass to each other on the edges, as well as correct position of the seals and downforce strip
			Check restrictor setting
		No good flame under ionization pin (suffocating flame)	Check position blocks/chips
		Ionisation electrode not inserted correctly	Place the electrode in the right place
		Blocked ionization electrode (measure ionization current flow, when > 0 and < 1.8 μ A)	Remove any residue vermiculite or debris from the burner
		Faulty ionisation electrode (measure ionisation current if 0 electrode is damaged)	Replace the ionisation electrode
		Triggered shock sensor (shake)	Check the sensor connection. Check whether the construction of the fire housing has not been damaged (cracked)
F12	There has been no release of ESYS	ESYS under permanent blockade	Wait half an hour until ESYS resets itself
F13/F14	(ionisation < 0.8 μ A) Flame loss when only the main burner (F13) is on or both burners (F14) are on	Too low gas pressure or no gas in the system	Check the gas supply
		Damage to the coil of the gas valve	Replace the coil of the gas valve
		Throttling flame	Check the patency of the combustion air system
		24 hour control	Reset using the remote control
		Ionisation pin short-circuited	Remove chips, vermiculite or glow material lying against the ionisation pin
		Ionisation current too critical (0.8 \leq ionisation < 1.8 μ A)	Increase ionisation current to \geq 1.8 μ A by rearranging vermiculite, and removing chips and dust from the burner openings
F15	No automatic control ESYS	Loosening of the automation control	Fix the automatic control
		Not properly installed automatic control	Install properly automatic control
	High Limit error	Electrodes by the gas adjustment block connector are bent	Straighten them
		Damage to the bridge of the upper limit	Check the bridge of the upper limit ESYS
F16	Hardware failure ESYS	Damage ESYS (burner module)	Exchange ESYS (burner module)
F17	Temporary fireplace blockade	3 times turning on device failure	Wait 30 minutes, turn the device on

Table 7: Troubleshooting

15.MAINTENANCE

WARNING! The device should be maintained and serviced by a competent installer.

At least once a year the unit should be checked in order to operate properly and safely. The device cannot be used in case of damage or glass breakage. In this case, close the gas valve and immediately have the glass replaced. Do not change the design and sealed components or modify factory settings of the device under no circumstances.

The user can clean the exterior of the device, without using for this purpose corrosive and aggressive detergents. The warranty does not cover damage to the paint resulting from mechanical damage e.g. falling objects or placing them at the border of the device.

WARNING! It is forbidden to clean the device and the interior of the combustion chamber with a vacuum cleaner.

15.1. Spare parts

Use only original spare parts, which are available from the supplier.

15.2. Cleaning of the glass with anti-reflective coating (if delivered)

WARNING! The glass must be removed and cleaned only when it is cooled down to room temperature, and the device is turned off.

To prevent damage to the coating layer on the anti-reflective glass is prohibited to use hard sponges, steel wool, abrasive cleaners and cleaning products containing ammonia.

Most of the sediments formed on the glass can be removed with a microfiber cloth. Other materials, such as paper or kitchen towels, etc., may cause scratches and in the case of anti-reflective glass can also cause permanent damage to the coating. Use only chemically inert cleaners (neither acidic nor alkaline), for example. Instanet or Glassex.

Glass must first be wiped from both sides carefully with a damp cloth (or a soft sponge) to collect all the dirt and then wipe it with a dry Microfiber cloth that came with your device. Always thoroughly dry the glass as formed on the surface stains can irreversibly melt into the glass. In the case of larger dirt, for pre cleaning of the glass, you can use liquid for cleaning ceramic hobs or window glasses. But always at the end of the glass cleaning process, make sure you wipe it dry (after washing off the cleaning liquid with clean water) with a microfiber cloth attached to the device. If the glass is transferred by means of vacuum suction, keep in mind that the rubber suction cup must be clean and dry to avoid damaging the anti-reflective coating. If visible traces of the suction cup will remain on the glass, they should be removed.

WARNING! You should avoid leaving fingerprints on the glass. They will be burned out on it after the device starts working and you will not be able to remove them. The frequency of cleaning the glass should depend on the assessment of the contamination degree.

16.ENVIRONMENTAL PROTECTION

Packaging materials must be utilized in accordance with regulations. Batteries are considered to be small chemical waste and should be disposed in special containers.

16.1. The device

When the unit reaches the end of its life, you should proceed carefully, so the parts are suitable for reuse.

Before removing the device, you should do the following:

- Close the gas valve.
- Disconnect the 230 V AC.
- Unscrew the cable connecting the device to the gas valve.
- Remove the device.

Do not place the product in unsorted waste and take it to an official collection point for this type of waste. For this purpose, please contact your local authorities for information about the available systems of delivery and acceptance of this type of waste.

17.DELIVERY

After successful installation of the device, the installer is obliged to explain to the user how to operate the device and give him instructions how to start the device, security measures, use of the remote control and annual maintenance.

Additionally, the installer must provide the user with the following information and instructions:

- In case of perceived irregularities in the operation of the device, immediately close the gas valve and contact your installer in order to avoid dangerous situations.
- Indicate the user to the location of the gas valve.
- Pay attention to the preventive measures listed in the User Manual which protect against inadvertent ignition by other wireless remote controls, such as car keys and remote controls for garage doors.
- Pay attention to the fact that the device is connected to 230 V.
- Instruct the user on the device and use the remote control.
- Issue the user with manual and assembly instructions and advised that all instructions must be kept near the unit.
- Tell the User that is required to read the Safety Instructions contained in the Manual and that all instructions must be stored for the lifetime of the device.
- When the device is put into operation, it must be pointed out that:
 - When the unit is lit for the first time, it comes to the evaporation of volatile components from paint, materials, etc. and during the volatilization of these substances, the device should work with the highest heat load.
 - The room should be well ventilated.

18. TECHNICAL SPECIFICATIONS

TECHNICAL SPECIFICATIONS								
Name of the product	MONROE 900 F, MONROE 900 LF, MONROE 900 FR, MONROE 900 LFR							
Type of the device	To be built-in							
Combustion	Closed combustion chamber							
Supply and discharge system	Concentric Flue System 200/130							
Flame protection version	Separate ignition and ionization electrodes							
The safety valves for the purpose of pressure compensation	Yes							
Circulation hole in the fireplace wall	300 cm ²							
Type of the device	C11/C31/C91							
Appliance category	I2E(20), I2H(20)	I2L(25)	I2E+(20/25)	I2K(25)	I3P(30) I3P(37) I3P(50)	I3B/P(30) I3B/P(37) I3B/P(50)	I3+(30/37)	
Reference Gas	G20	G25	G20/G25	G25.3	G31	G30	G30/G31	
Nominal heat input (Hi)	kW	11				12,2		
Consumption on max output	m ³ /h	1,17				-		
Consumption on low output	m ³ /h	0,22 (*)				-		
Consumption on max output	kg/h	-				0,96		
Consumption on low output	kg/h	-				0,20 (*)		
Maximum burner pressure	mbar	10,5	24,0	19,0	23,0	27	27	26
Minimum burner pressure	mbar	5,0	9,5	9,5	10,2	9	9	9
Nozzle of the main burner	mm	1x Ø1,75	1x Ø1,5	1x Ø1,5	1x Ø1,5	1x Ø1,2	1x Ø1,1	1x Ø1,05
Nozzles of the side burner	mm	1x Ø1,75; 2x Ø1,5	1x Ø1,5; 2x Ø1,35	1x Ø1,5; 2x Ø1,35	1x Ø1,5; 2x Ø1,35	3x Ø1,1	3x Ø1,0	3x Ø0,95
Efficiency class		Class 2	Class 2	Class 2	Class 2	Class 2	Class 2	Class 2
* - on minimal output, only the middle section switched on								

19. WARRANTY

Planika Sp. z o.o. grants the Client guarantee of quality for the smooth operation of the goods specified on the sales document. The warranty is determined for a given period from the date of purchase (based on the warranty card together with the receipt of purchase). The warranty period starts at the moment of purchase of the original product by the first end user. Product may consist of several separate parts and different parts may be covered by a different warranty periods. The manufacturer gives 2 year warranty from date of purchase an insert for its smooth operation. Fireplace sealing is covered by warranty for a period of 1 year from date of purchase of the device. Guarantee does not cover: decorative elements and glass. The use of the fireplace insert, way of connecting to the chimney and operating conditions must be in accordance with the user manual. The basis for the free repair covered by warranty is a warranty card. Warranty Card will expire without a date, stamps, signatures, as well as the amendments made by unauthorized persons. Customer entitlement under the guarantee will expire automatically: after the warranty period. Any damages caused by improper handling, storage, of poor maintenance, incompatible with the conditions laid down in the manual and due to other reasons not due to the fault of the manufacturer, will void the warranty. In the event of a complaint, always contact your dealer. Supplier will contact the company Planika, if it deems it necessary. Factory Warranty is valid for 2 years from the date of purchase. Details of the warranty are available on the <https://www.planikafires.com/warranty-cards/>

SELLER	
Name:	Seller's seal and signature
Address:	
Tel/fax:	
Date of sale:	
BUYER	
Name:	
Address:	
Tel/fax:	
Date of purchase:	
<p>The gas fireplace should be installed by a qualified Installer in accordance with the applicable national building regulations and in accordance with the guidelines contained in the Installation and User's Manuals.</p>	
<p>I hereby declare that having read the User's Manual and the Guarantee Conditions.</p>	
<p>Date and legible signature of the Buyer</p>	
INSTALLER	
Name:	
Address:	
Tel/fax:	
Date of commissioning:	
<p>I hereby declare that the gas fireplace installed by my Company has been installed in accordance with the applicable building regulations and in accordance with the guidelines contained in the Installation and User's Manuals. The installed gas fireplace is ready for safe operation.</p>	
<p>Installer's seal and signature</p>	

REGISTER OF APPLIANCE INSPECTIONS

REGISTER OF CONCENTRIC FLUE SYSTEM INSPECTIONS

Inspection during the fireplace installation	Date, signature and seal of the chimney sweeper
Date, signature and seal of the chimney sweeper	Date, signature and seal of the chimney sweeper
Date, signature and seal of the chimney sweeper	Date, signature and seal of the chimney sweeper
Date, signature and seal of the chimney sweeper	Date, signature and seal of the chimney sweeper
Date, signature and seal of the chimney sweeper	Date, signature and seal of the chimney sweeper